

**POWER Units for
Gensets (Saran)
2.9L/4039/4.5/6.8L
(128/008/158/258)**

**OPERATOR'S
MANUAL**



**John Deere Usine de Saran
OMCD16564 (03JAN00)**

Printed in Germany
ENGLISH



Introduction

THIS MANUAL COVERS the following engines for generator sets:

ENGINE FAMILY	ENGINE MODEL	
300-SERIES	CD3029DF128	
	CD4039DF008	
POWERTECH®	CD4039TF008	
	CD4045DF158	
	CD4045HF158	
	CD4045TF158	
	CD4045TF258	
	CD6068HF158	
	CD6068TF158	
	CD6068TF258	

READ THIS MANUAL carefully to learn how to operate and service your engine correctly. Failure to do so could result in personal injury or equipment damage.

THIS MANUAL SHOULD BE CONSIDERED a permanent part of your engine and should remain with the engine when you sell it.

MEASUREMENTS IN THIS MANUAL are given in metric. Use only correct replacement parts and fasteners. Metric and inch fasteners may require a specific metric or inch wrench.

WRITE ENGINE SERIAL NUMBERS and option codes in the spaces indicated in the Record Keeping Section. Accurately record all the numbers. Your dealer also needs these numbers when you order parts. File the identification numbers in a secure place off the engine or machine.

RIGHT-HAND AND LEFT-HAND sides are determined by standing at the drive or flywheel end (rear) of the engine and facing toward the front of the engine.

SETTING FUEL DELIVERY beyond published factory specifications or otherwise overpowering will result in loss of warranty protection for this engine.

Information relative to emissions regulations

Depending on final destination, this engine can meet the emissions regulations according to the US Environmental Protection Agency (EPA), California Air Resources Board (CARB) and for Europe, the Directive 97/68/EC relating the measures against the emissions of gaseous and particulates pollutants from internal combustion engines. In this case an emission label is stuck on the engine.

Emission regulations prohibit tampering with the emission-related components listed below which would render that component inoperative or to make any adjustment on the engine beyond published specifications. It is also illegal to install a part or component where the principal effect of that component is to bypass, defeat, or render inoperative any engine component or device which would affect the engine conformance to the emissions regulations. To summarize, it is illegal to do anything except return the engine to its original published specifications.

List of emission-related components:

- Fuel injection pump
- Intake manifold
- Turbocharger
- Charge air cooling system
- Piston

CALIFORNIA PROPOSITION 65 WARNING
Diesel engine exhaust and some of its constituents are known to the State of California to cause cancer, birth defects and other reproductive harm.

Contents

	Page		Page
Identification Views		Diesel Engine Coolant	10-4
Identification views	01-1	Operating in Warm Temperature Climates	10-5
Maintenance Records		Operating the Engine	
Using maintenance records	02-1	Break-in period	15-1
100 Hours of operation	02-1	Starting the engine	15-1
500 Hours of operation	02-2	Cold weather operation	15-1
1000 Hours of operation	02-2	Using a booster battery or charger	15-3
1500 Hours of operation	02-3	Engine operation	15-4
2000 Hours of operation	02-3	Standby power units	15-4
2500 Hours of operation	02-4	Stopping the engine	15-5
3000 Hours of operation	02-4		
3500 Hours of operation	02-5	Maintenance	
4000 Hours of operation	02-5	Observe service intervals	20-1
4500 Hours of operation	02-6	Use correct fuels, lubricants and coolant	20-1
5000 Hours of operation	02-6	Maintenance interval chart	20-2
5500 Hours of operation	02-7		
6000 Hours of operation	02-7	Maintenance/Daily or every 10 hours	
6500 Hours of operation	02-8	Daily prestarting checks	25-1
7000 Hours of operation	02-8		
7500 Hours of operation	02-9	Maintenance/500 hours	
8000 Hours of operation	02-9	Changing engine oil and filter	30-1
8500 Hours of operation	02-10	Replacing fuel filter element	30-3
9000 Hours of operation	02-10	Checking belt (300-SERIES ENGINES)	30-4
9500 Hours of operation	02-11	Checking belt (POWERTech ENGINES with manual tensioner)	30-5
10000 Hours of operation	02-11		
Record Keeping		Maintenance/1000 hours/1 year	
POWERTech® medallion	03-1	Cleaning crankcase vent tube	35-1
Engine serial number plate	03-1	Checking air intake system	35-1
Record engine serial number	03-2	Checking automatic belt tensioner (POWERTech ENGINES)	35-2
Engine option codes	03-3	Check and adjust engine valve clearance (300-SERIES ENGINES)	35-3
Record fuel injection pump model number	03-5		
Safety	05-1	Maintenance/2000 hours/2 years	
		Check and adjust engine valve clearance (POWERTech ENGINE)	40-1
Fuels, Lubricants and Coolant		Checking engine speed	40-3
Diesel Fuel	10-1	Adjust speed droop governor	40-3
Handling and Storing Diesel Fuel	10-1		
Engine Break-In Oil	10-2		
Diesel Engine Oil	10-3		
Lubricant Storage	10-3		
Mixing of Lubricants	10-4		

Continued on next page

All information, illustrations and specifications in this manual are based on the latest information available at the time of publication. The right is reserved to make changes at any time without notice.

COPYRIGHT © 1999
DEERE & COMPANY
European Office Mannheim
All rights reserved
A John Deere ILLUSTRATION® Manual

Page

Checking crankshaft vibration damper
(6-CYLINDER ENGINE ONLY) 40-4

Maintenance/2500 hours/3 years

Drain and flush cooling system 45-1

Maintenance/As required

Additional service information 50-1

Do not modify fuel system 50-1

Clean or replace air filter (one-piece) 50-2

Clean or replace air filter element 50-3

Replacing fan and alternator belt
(POWERTECH ENGINES) 50-4

Checking fuel filter 50-5

Bleeding the fuel system 50-6

Troubleshooting

Engine troubleshooting 55-1

Electrical troubleshooting 55-6

Storage

Engine storage guidelines 60-1

Use AR41785 engine storage kit 60-1

Preparing engine for long term storage 60-2

Removing engine from long term storage 60-3

Specifications

General engine specifications 65-1

Unified Inch Bolt and Cap Screw Torque
Values 65-4

Metric Bolt and Cap Screw Torque Values 65-5

Identification Views

IDENTIFICATION VIEWS

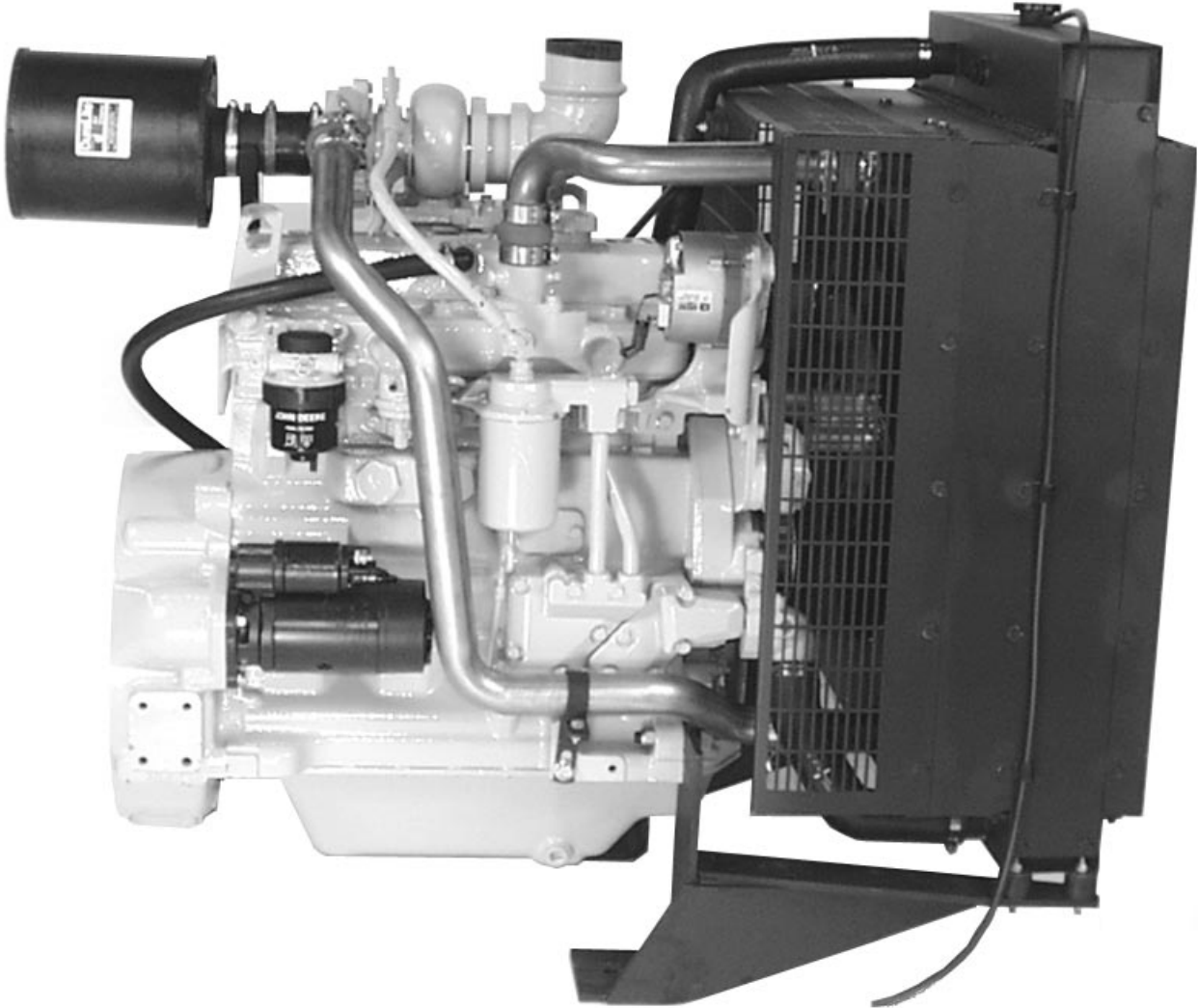

4045HF158

CD30744 -JUN-23AUG99

Continued on next page

DPSG,CD03523,3 -19-05JUL99-1/2

Identification Views

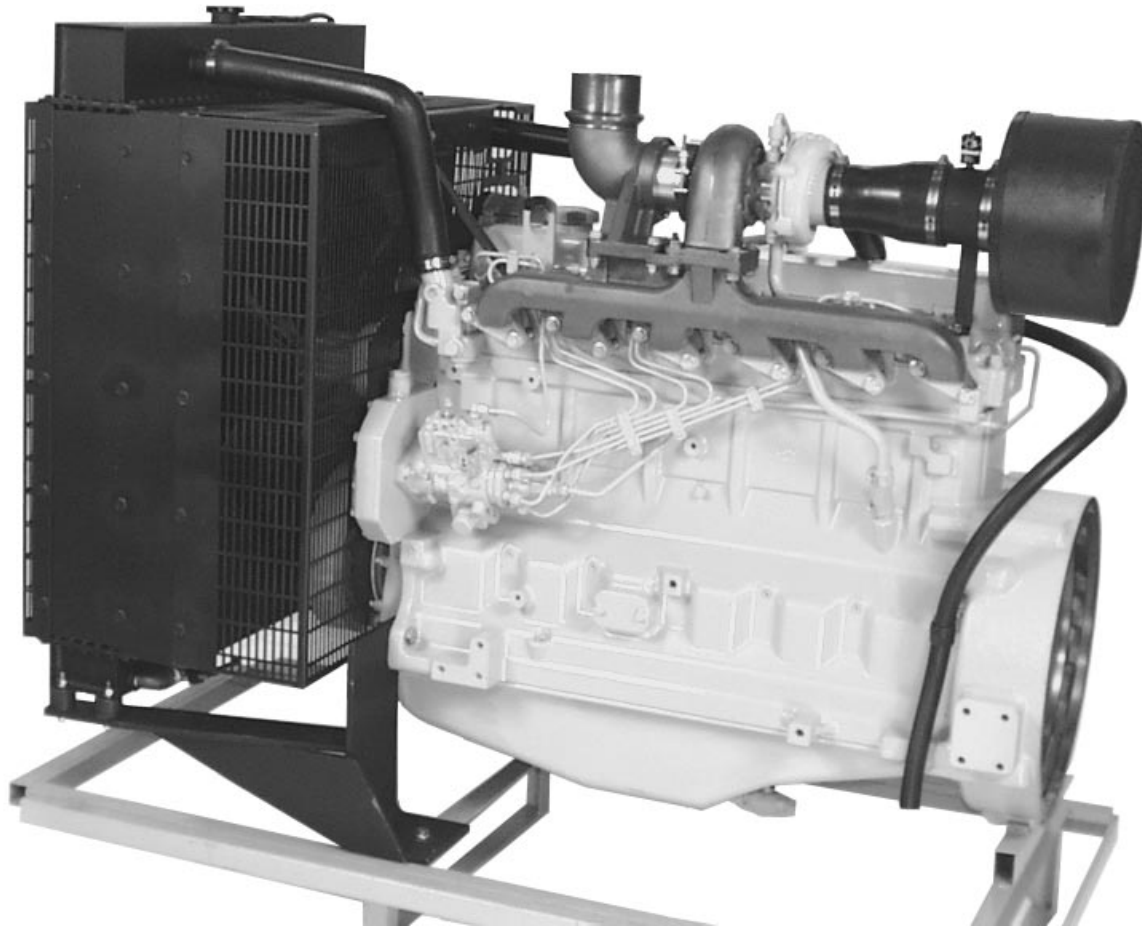

6068HF158

CD30745 -UN-23AUG99

DPSG,CD03523,3 -19-05JUL99-2/2

Maintenance Records

USING MAINTENANCE RECORDS

To obtain the best performance, economy and service life from your engine, ensure service is carried out according to this present manual and recorded in the following pages. It is recommended that your engine Distributor or your Dealer carry out this service work and stamp the appropriate case.

Keeping an accurate account of all service performed on your engine will give more value to the machine when you resell it.

John Deere oils and coolants have been formulated to give maximum protection and performance to your engine. We recommend only genuine John Deere service products and replacement parts.

To protect your rights under the warranty ensure all scheduled services are carried out and recorded. If your engine is covered by extended warranty, it is important to maintain this record for the duration of the warranty.

DPSG,CD03523,6 -19-05JUL99-1/1

100 HOURS OF OPERATION

- Engine oil, replace
- Engine oil filter, replace
- Hose connections, check

Number of hours:

Comments:

Dealer or distributor stamp

Date:

Job done by:

DPSG,CD03523,7 -19-05JUL99-1/1

Maintenance Records

500 HOURS OF OPERATION

- Engine oil, replace
- Engine oil filter, replace

- Fuel filter, replace

- Belt, check tension and wear (300-Series and POWERTech with manual tensioner)

- Valve clearance, adjust (300-Series)

Number of hours:	Comments:	Dealer or distributor stamp
Date:		
Job done by:		

DPSG,CD03523,8 -19-05JUL99-1/1

1000 HOURS OF OPERATION

- Engine oil, replace
- Engine oil filter, replace
- Fuel filter, replace
- Check belt and tensioning system
- Crankcase vent tube, clean

- Air intake system, check

Number of hours:	Comments:	Dealer or distributor stamp
Date:		
Job done by:		

DPSG,CD03523,9 -19-05JUL99-1/1

1500 HOURS OF OPERATION

- Engine oil, replace
- Engine oil filter, replace
- Fuel filter, replace
- Belt, check tension and wear (300-Series and POWERTech with manual tensioner)
- Valve clearance, adjust (300-Series)

Number of hours:	Comments:	Dealer or distributor stamp
Date:		
Job done by:		

DPSG,CD03523,10 -19-05JUL99-1/1

2000 HOURS OF OPERATION

- Engine oil, replace
- Engine oil filter, replace
- Fuel filter, replace
- Check belt and tensioning system
- Crankcase vent tube, clean
- Cooling system, drain and flush (if COOL-GARD is not used)
- Valve clearance, adjust (POWERTech)
- Air intake system, check
- Vibration damper, check

Number of hours:	Comments:	Dealer or distributor stamp
Date:		
Job done by:		

DPSG,CD03523,59 -19-16AUG99-1/1

Maintenance Records

2500 HOURS OF OPERATION

- Engine oil, replace
- Engine oil filter, replace
- Fuel filter, replace
- Belt, check tension and wear (300-Series and POWERTech with manual tensioner)
- Valve clearance, adjust (300-Series)
- Cooling system, drain and flush (if COOL-GARD is used)

Number of hours:	Comments:	Dealer or distributor stamp
Date:		
Job done by:		

DPSG,CD03523,60 -19-16AUG99-1/1

3000 HOURS OF OPERATION

- Engine oil, replace
- Engine oil filter, replace
- Fuel filter, replace
- Check belt and tensioning system
- Crankcase vent tube, clean
- Air intake system, check

Number of hours:	Comments:	Dealer or distributor stamp
Date:		
Job done by:		

DPSG,CD03523,61 -19-16AUG99-1/1

3500 HOURS OF OPERATION

- Engine oil, replace
- Engine oil filter, replace
- Fuel filter, replace
- Belt, check tension and wear (300-Series and POWERTech with manual tensioner)
- Valve clearance, adjust (300-Series)

Number of hours:	Comments:	Dealer or distributor stamp
Date:		
Job done by:		

DPSG,CD03523,62 -19-16AUG99-1/1

4000 HOURS OF OPERATION

- Engine oil, replace
- Engine oil filter, replace
- Fuel filter, replace
- Check belt and tensioning system
- Crankcase vent tube, clean
- Cooling system, drain and flush (if COOL-GARD is not used)
- Valve clearance, adjust (POWERTech)
- Air intake system, check
- Vibration damper, check

Number of hours:	Comments:	Dealer or distributor stamp
Date:		
Job done by:		

DPSG,CD03523,63 -19-16AUG99-1/1

Maintenance Records

4500 HOURS OF OPERATION

- Engine oil, replace
- Engine oil filter, replace
- Fuel filter, replace
- Belt, check tension and wear (300-Series and POWERTech with manual tensioner)
- Valve clearance, adjust (300-Series)
- Vibration damper, replace (6 cyl.)

Number of hours:	Comments:	Dealer or distributor stamp
Date:		
Job done by:		

DPSG,CD03523,64 -19-16AUG99-1/1

5000 HOURS OF OPERATION

- Engine oil, replace
- Engine oil filter, replace
- Fuel filter, replace
- Check belt and tensioning system
- Crankcase vent tube, clean
- Injection nozzles, replace
- Air intake system, check
- Cooling system, drain and flush (if COOL-GARD is used)

Number of hours:	Comments:	Dealer or distributor stamp
Date:		
Job done by:		

DPSG,CD03523,65 -19-16AUG99-1/1

5500 HOURS OF OPERATION

- Engine oil, replace
- Engine oil filter, replace
- Fuel filter, replace
- Belt, check tension and wear (300-Series and POWERTech with manual tensioner)
- Valve clearance, adjust (300-Series)

Number of hours:	Comments:	Dealer or distributor stamp
Date:		
Job done by:		

DPSG,CD03523,66 -19-16AUG99-1/1

6000 HOURS OF OPERATION

- Engine oil, replace
- Engine oil filter, replace
- Fuel filter, replace
- Check belt and tensioning system
- Crankcase vent tube, clean
- Cooling system, drain and flush (if COOL-GARD is not used)
- Valve clearance, adjust (POWERTech)
- Air intake system, check
- Vibration damper, check

Number of hours:	Comments:	Dealer or distributor stamp
Date:		
Job done by:		

DPSG,CD03523,67 -19-16AUG99-1/1

Maintenance Records

6500 HOURS OF OPERATION

- Engine oil, replace
- Engine oil filter, replace
- Fuel filter, replace
- Belt, check tension and wear (300-Series and POWERTech with manual tensioner)
- Valve clearance, adjust (300-Series)

Number of hours:	Comments:	Dealer or distributor stamp
Date:		
Job done by:		

DPSG,CD03523,68 -19-16AUG99-1/1

7000 HOURS OF OPERATION

- Engine oil, replace
- Engine oil filter, replace
- Fuel filter, replace
- Check belt and tensioning system
- Crankcase vent tube, clean
- Air intake system, check

Number of hours:	Comments:	Dealer or distributor stamp
Date:		
Job done by:		

DPSG,CD03523,69 -19-16AUG99-1/1

7500 HOURS OF OPERATION

- | | |
|--|---|
| <input type="checkbox"/> Engine oil, replace | <input type="checkbox"/> Cooling system, drain and flush (if COOL-GARD is used) |
| <input type="checkbox"/> Engine oil filter, replace | |
| <input type="checkbox"/> Fuel filter, replace | |
| <input type="checkbox"/> Belt, check tension and wear (300-Series and POWERTech with manual tensioner) | |
| <input type="checkbox"/> Valve clearance, adjust (300-Series) | |

Number of hours: Date: Job done by:	Comments:	Dealer or distributor stamp
---	-----------	-----------------------------

DPSG,CD03523,70 -19-16AUG99-1/1

8000 HOURS OF OPERATION

- | | |
|---|---|
| <input type="checkbox"/> Engine oil, replace | <input type="checkbox"/> Cooling system, drain and flush (if COOL-GARD is not used) |
| <input type="checkbox"/> Engine oil filter, replace | <input type="checkbox"/> Valve clearance, adjust (POWERTech) |
| <input type="checkbox"/> Fuel filter, replace | <input type="checkbox"/> Air intake system, check |
| <input type="checkbox"/> Check belt and tensioning system | <input type="checkbox"/> Vibration damper, check |
| <input type="checkbox"/> Crankcase vent tube, clean | |

Number of hours: Date: Job done by:	Comments:	Dealer or distributor stamp
---	-----------	-----------------------------

DPSG,CD03523,71 -19-16AUG99-1/1

8500 HOURS OF OPERATION

- Engine oil, replace
- Engine oil filter, replace
- Fuel filter, replace
- Belt, check tension and wear (300-Series and POWERTech with manual tensioner)
- Valve clearance, adjust (300-Series)

Number of hours:	Comments:	Dealer or distributor stamp
Date:		
Job done by:		

DPSG,CD03523,72 -19-16AUG99-1/1

9000 HOURS OF OPERATION

- Engine oil, replace
- Engine oil filter, replace
- Fuel filter, replace
- Check belt and tensioning system
- Crankcase vent tube, clean
- Air intake system, check
- Vibration damper, replace (6 cyl.)

Number of hours:	Comments:	Dealer or distributor stamp
Date:		
Job done by:		

DPSG,CD03523,73 -19-16AUG99-1/1

9500 HOURS OF OPERATION

- Engine oil, replace
- Engine oil filter, replace
- Fuel filter, replace
- Belt, check tension and wear (300-Series and POWERTech with manual tensioner)
- Valve clearance, adjust (300-Series)

Number of hours:	Comments:	Dealer or distributor stamp
Date:		
Job done by:		

DPSG,CD03523,74 -19-16AUG99-1/1

10000 HOURS OF OPERATION

- Engine oil, replace
- Engine oil filter, replace
- Fuel filter, replace
- Check belt and tensioning system
- Crankcase vent tube, clean
- Air intake system, check
- Cooling system, drain and flush
- Valve clearance, adjust (POWERTech)
- Thermostat, replace
- Vibration damper, check
- Injection nozzles, replace

Number of hours:	Comments:	Dealer or distributor stamp
Date:		
Job done by:		

DPSG,CD03523,75 -19-16AUG99-1/1

Record Keeping

POWERTECH® MEDALLION

A medallion is located on the rocker arm cover which identifies each engine as a John Deere POWERTECH® engine.

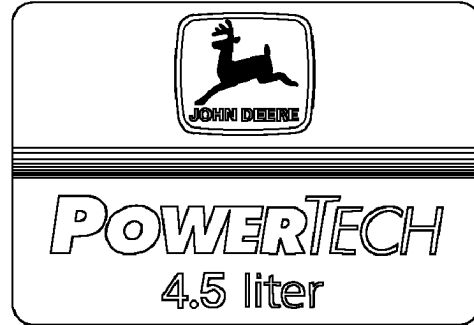

RG8041 -UN-15JAN99

POWERTECH is a trademark of Deere & Company

DPSG.CD03523,11 -19-05JUL99-1/1

ENGINE SERIAL NUMBER PLATE

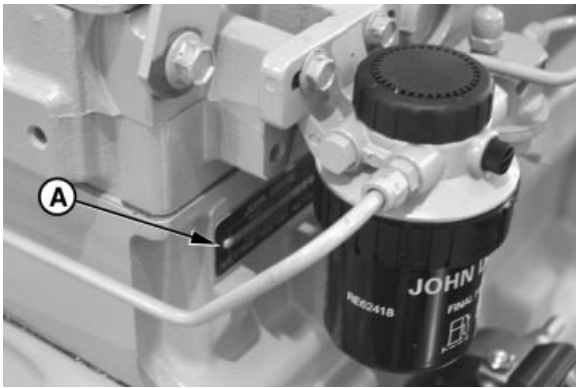

RG8007 -UN-15JAN99

POWERTEch engine

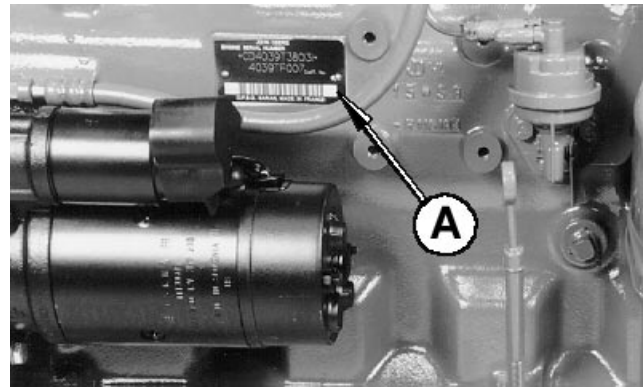

CD30746 -UN-24SEP99

300-Series engine

Each engine has a 13-digit John Deere serial number. The first two digits identify the factory that produced the engine:

“CD” indicates the engines was built in Saran, France.

Your engine's serial number plate (A) is located on the right-hand side of cylinder block behind the fuel filter for POWERTEch engines and near the fuel supply pump on 300-Series engines.

DPSG.CD03523,12 -19-05JUL99-1/1

RECORD ENGINE SERIAL NUMBER

Record all of the numbers and letters found on your engine serial number plate in the spaces provided below.

This information is very important for repair parts or warranty information.

Engine Serial Number (B)

Engine Model Number (C)

Coefficient of Absorption Value (D)



CD30705B -UN-24AUG99

300-Series engine plate



CD30747 -UN-23AUG99

POWERTech engine plate

DPSG,CD03523,13 -19-05JUL99-1/1

ENGINE OPTION CODES



Engine option code label

In addition to the serial number plate, OEM engines have an engine option code label affixed to the rocker arm cover. These codes indicate which of the engine options were installed on your engine at the factory. When in need of parts or service, furnish your authorized servicing dealer or engine distributor with these numbers.

An additional sticker may be also delivered (in a plastic bag attached to the engine or inserted in the machine documentation). It is recommended to stick this option code list sticker either:

- On this page of your Operator's manual below this section.
- or
- On the "Engine Owner's Warranty" booklet under the title OPTION CODES (Engine manufacturing configuration).

NOTE: The Machine Manufacturer may have already stuck it at a specific accessible place (inside the enclosure or close to a maintenance area).

The engine option code label includes an engine base code (A). This base code must also be recorded along with the option codes. At times it will be necessary to furnish this base code to differentiate two identical option codes for the same engine model.

The first two digits of each code identify a specific group, such as alternators. The last two digits of each code identify one specific option provided on your engine, such as a 12-volt, 55-amp alternator.

NOTE: These option codes are based on the latest information available at the time of publication. The right is reserved to make changes at any time without notice.

If an engine is ordered without a particular component, the last two digits of that functional group option code will be 99, 00, or XX. The list on the next page shows only the first two digits of the code numbers. For future reference such as ordering repair parts, it is important to have these code numbers available. To ensure this availability, enter the third and fourth digits shown on your engine option code label in the spaces provided on the following page.

NOTE: Your engine option code label may not contain all option codes if an option has been added after the engine left the producing factory.

If option code label is lost or destroyed, consult your servicing dealer or engine distributor selling the engine for a replacement.

Record Keeping

Option Codes	Description	Option Codes	Description
Engine Base Code: _____			
11___	Rocker Arm Cover	45___	Balancer Shaft
12___	Oil Filler Neck	46___	Cylinder Block With Liners and Camshaft
13___	Crankshaft Pulley	47___	Crankshaft and Bearings
14___	Flywheel Housing	48___	Connecting Rods and Pistons
15___	Flywheel	49___	Valve Actuating Mechanisms
16___	Fuel Injection Pump	50___	Oil Pump
17___	Air inlet	51___	Cylinder Head With Valves
18___	Air cleaner	52___	Auxiliary Gear Drive
19___	Oil pan	54___	Oil heater
20___	Coolant pump	55___	Shipping stand
21___	Thermostat Cover	56___	Paint Option
22___	Thermostat	57___	Coolant Inlet
23___	Fan Drive	59___	Oil Cooler
24___	Fan Belt	60___	Add-on Auxiliary Drive Pulley
25___	Fan	62___	Alternator Mounting
26___	Engine Coolant Heater	64___	Exhaust Elbow
27___	Radiator	65___	Turbocharger
28___	Exhaust Manifold	66___	Temperature Switch
29___	Ventilator System	67___	Electronic Tachometer Sensor
30___	Starting Motor	68___	Damper
31___	Alternator	69___	Engine Serial Number Plate
32___	Instrument Panel	74___	Air Conditioning System Compressor Mounting
35___	Fuel Filter	75___	Air Restriction Indicator
36___	Front Plate	76___	Oil Pressure Switch
37___	Fuel Transfer Pump	86___	Fan Pulley
39___	Thermostat Housing	87___	Automatic Belt Tensioner
40___	Oil Dipstick	88___	Oil Filter
41___	Belt Driven Front Auxiliary Drive	91___	Special Equipment (Factory Installed)
43___	Starting Aid	97___	Special Equipment (Field Installed)
44___	Timing Gear Cover with Gears	98___	Shipping

DPSG,CD03523,14 -19-05JUL99-2/2

RECORD FUEL INJECTION PUMP MODEL NUMBER

Record the fuel injection pump model and serial information found on the serial number plate (A).

Model No. _____ RPM _____

Manufacturer's No. _____

Serial No. _____

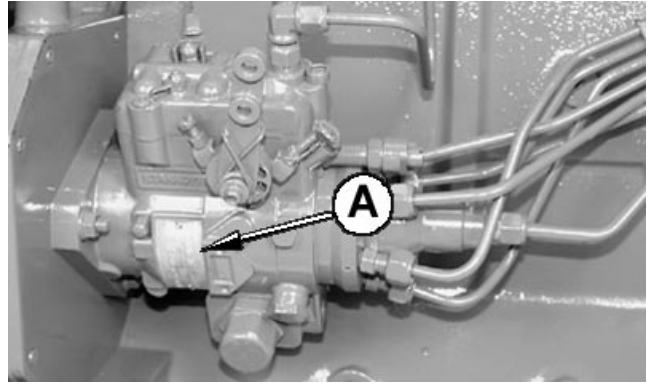

DPSG,CD03523,15 -19-07JUL99-1/1

Safety

RECOGNIZE SAFETY INFORMATION

This is a safety-alert symbol. When you see this symbol on your machine or in this manual, be alert to the potential for personal injury.

Follow recommended precautions and safe operating practices.



DX,ALERT -19-29SEP98-1/1

T81389 -JUN-07DEC88

UNDERSTAND SIGNAL WORDS

A signal word—DANGER, WARNING, or CAUTION—is used with the safety-alert symbol. DANGER identifies the most serious hazards.

DANGER or WARNING safety signs are located near specific hazards. General precautions are listed on CAUTION safety signs. CAUTION also calls attention to safety messages in this manual.



▲ WARNING

▲ CAUTION

DX,SIGNAL -19-03MAR93-1/1

TS187 -19-30SEP88

ENGINE LIFTING PROCEDURE



CAUTION: The only recommended method for lifting the engine is with JDG23 Engine Lifting Sling (A) and safety approved lifting straps (B) that come with engine. Use extreme caution when lifting and NEVER permit any part of the body to be positioned under an engine being lifted or suspended.

Lift engine with longitudinal loading on lifting sling and lifting straps only. Angular loading greatly reduces lifting capacity of sling and straps.

NOTE: If engine does not have lifting straps, universal straps can be procured through service parts under part numbers JD-244-1 and JD-244-2.

1. If not equipped, install lifting straps and torque to 200 N•m (145 lb-ft).
2. Attach JDG23 Engine Lifting Sling (A) to engine lifting straps (B) and overhead hoist.

IMPORTANT: Lifting straps are designed to lift the engine and accessories such as radiator, air filter and other small components. If larger components, such as power take-off, transmission, generator air compressor... etc, are attached to engine, the lifting straps provided with engine or through parts channel are not intended for this purpose. Technician is responsible for providing adequate lifting devices under these situations. See machine manuals for additional information on removing engine from machine.

3. Carefully move engine to desired location.

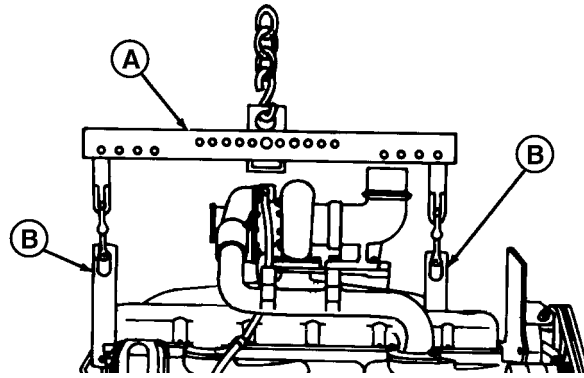

RG7784 -UN-11NOV97

FOLLOW SAFETY INSTRUCTIONS

Carefully read all safety messages in this manual and on your machine safety signs. Keep safety signs in good condition. Replace missing or damaged safety signs. Be sure new equipment components and repair parts include the current safety signs. Replacement safety signs are available from your John Deere dealer.

Learn how to operate the machine and how to use controls properly. Do not let anyone operate without instruction.

Keep your machine in proper working condition. Unauthorized modifications to the machine may impair the function and/or safety and affect machine life.

If you do not understand any part of this manual and need assistance, contact your John Deere dealer.



TS201 -UN-23AUG88

DX,READ -19-03MAR93-1/1

PREVENT MACHINE RUNAWAY

Avoid possible injury or death from machinery runaway.

Do not start engine by shorting across starter terminals. Machine will start in gear if normal circuitry is bypassed.

NEVER start engine while standing on ground. Start engine only from operator's seat, with transmission in neutral or park.



TS177 -UN-11JAN89

DX,BYPAS1 -19-29SEP98-1/1

HANDLE FUEL SAFELY—AVOID FIRES

Handle fuel with care: it is highly flammable. Do not refuel the machine while smoking or when near open flame or sparks.

Always stop engine before refueling machine. Fill fuel tank outdoors.

Prevent fires by keeping machine clean of accumulated trash, grease, and debris. Always clean up spilled fuel.



TS202 -UN-23AUG88

DX,FIRE1 -19-03MAR93-1/1

PREPARE FOR EMERGENCIES

Be prepared if a fire starts.

Keep a first aid kit and fire extinguisher handy.

Keep emergency numbers for doctors, ambulance service, hospital, and fire department near your telephone.

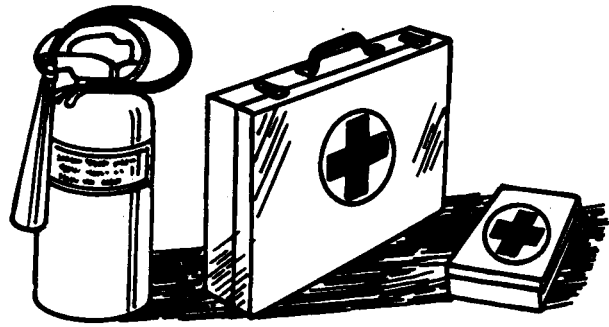

TS291 -UN-23AUG88

DX,FIRE2 -19-03MAR93-1/1

HANDLE STARTING FLUID SAFELY

Starting fluid is highly flammable.

Keep all sparks and flame away when using it. Keep starting fluid away from batteries and cables.

To prevent accidental discharge when storing the pressurized can, keep the cap on the container, and store in a cool, protected location.

Do not incinerate or puncture a starting fluid container.



TS1356 -UN-18MAR92

DX,FIRE3 -19-16APR92-1/1

WEAR PROTECTIVE CLOTHING

Wear close fitting clothing and safety equipment appropriate to the job.

Prolonged exposure to loud noise can cause impairment or loss of hearing.

Wear a suitable hearing protective device such as earmuffs or earplugs to protect against objectionable or uncomfortable loud noises.

Operating equipment safely requires the full attention of the operator. Do not wear radio or music headphones while operating machine.

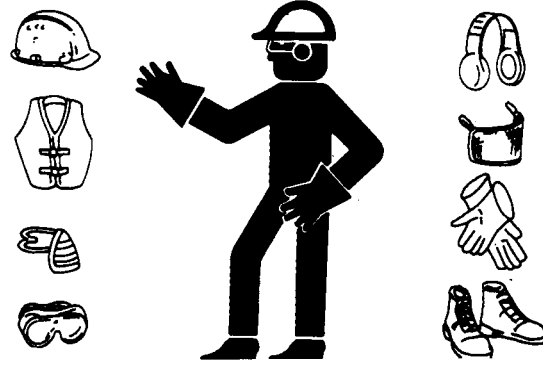

TS206 -UN-23AUG88

DX,WEAR -19-10SEP90-1/1

PROTECT AGAINST NOISE

Prolonged exposure to loud noise can cause impairment or loss of hearing.

Wear a suitable hearing protective device such as earmuffs or earplugs to protect against objectionable or uncomfortable loud noises.



TS207 -UN-23AUG88

DX,NOISE -19-03MAR93-1/1

HANDLE CHEMICAL PRODUCTS SAFELY

Direct exposure to hazardous chemicals can cause serious injury. Potentially hazardous chemicals used with John Deere equipment include such items as lubricants, coolants, paints, and adhesives.

A Material Safety Data Sheet (MSDS) provides specific details on chemical products: physical and health hazards, safety procedures, and emergency response techniques.

Check the MSDS before you start any job using a hazardous chemical. That way you will know exactly what the risks are and how to do the job safely. Then follow procedures and recommended equipment.

(See your John Deere dealer for MSDS's on chemical products used with John Deere equipment.)

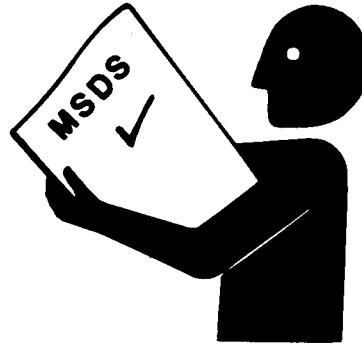

TS1132 -JUN-26NOV90

DX,MSDS,NA -19-03MAR93-1/1

STAY CLEAR OF ROTATING DRIVELINES

Entanglement in rotating driveline can cause serious injury or death.

Keep master shield and driveline shields in place at all times. Make sure rotating shields turn freely.

Wear close fitting clothing. Stop the engine and be sure the PTO driveline is stopped before making adjustments or performing any type service on the engine or PTO-driven equipment.



TS1644 -JUN-22AUG95

CD,PTO -19-12SEP95-1/1

PRACTICE SAFE MAINTENANCE

Understand service procedure before doing work. Keep area clean and dry.

Never lubricate, service, or adjust machine while it is moving. Keep hands, feet, and clothing from power-driven parts. Disengage all power and operate controls to relieve pressure. Lower equipment to the ground. Stop the engine. Remove the key. Allow machine to cool.

Securely support any machine elements that must be raised for service work.

Keep all parts in good condition and properly installed. Fix damage immediately. Replace worn or broken parts. Remove any buildup of grease, oil, or debris.

On self-propelled equipment, disconnect battery ground cable (-) before making adjustments on electrical systems or welding on machine.

On towed implements, disconnect wiring harnesses from tractor before servicing electrical system components or welding on machine.



TS218 -JUN-23AUG88

DX,SERV -19-17FEB99-1/1

WORK IN VENTILATED AREA

Engine exhaust fumes can cause sickness or death. If it is necessary to run an engine in an enclosed area, remove the exhaust fumes from the area with an exhaust pipe extension.

If you do not have an exhaust pipe extension, open the doors and get outside air into the area

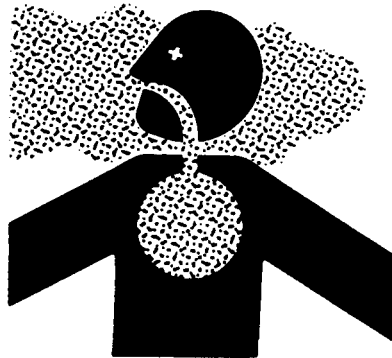

TS220 -JUN-23AUG88

DX,AIR -19-17FEB99-1/1

AVOID HIGH-PRESSURE FLUIDS

Escaping fluid under pressure can penetrate the skin causing serious injury.

Avoid the hazard by relieving pressure before disconnecting hydraulic or other lines. Tighten all connections before applying pressure.

Search for leaks with a piece of cardboard. Protect hands and body from high pressure fluids.

If an accident occurs, see a doctor immediately. Any fluid injected into the skin must be surgically removed within a few hours or gangrene may result. Doctors unfamiliar with this type of injury should reference a knowledgeable medical source. Such information is available from Deere & Company Medical Department in Moline, Illinois, U.S.A.

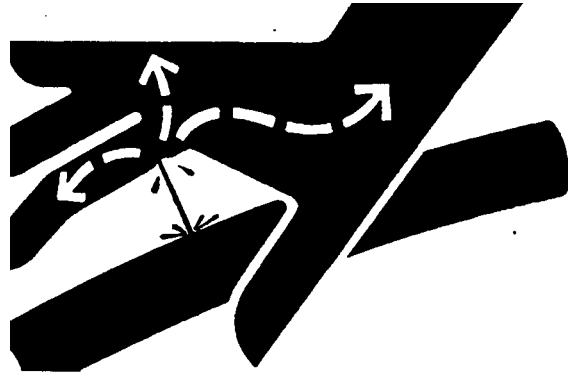

X9811 -UN-23AUG88

DX,FLUID -19-03MAR93-1/1

AVOID HEATING NEAR PRESSURIZED FLUID LINES

Flammable spray can be generated by heating near pressurized fluid lines, resulting in severe burns to yourself and bystanders. Do not heat by welding, soldering, or using a torch near pressurized fluid lines or other flammable materials. Pressurized lines can be accidentally cut when heat goes beyond the immediate flame area.

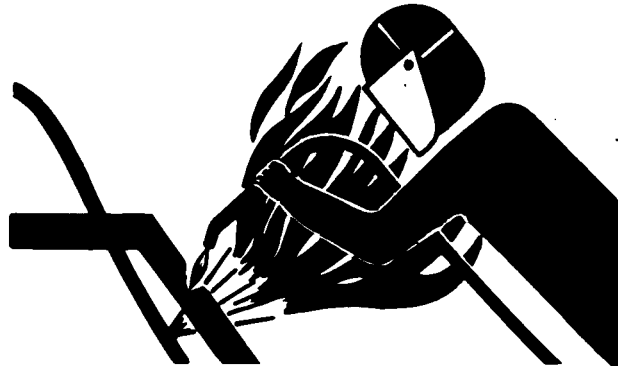

TS953 -UN-15MAY90

DX,TORCH -19-03MAR93-1/1

REMOVE PAINT BEFORE WELDING OR HEATING

Avoid potentially toxic fumes and dust.

Hazardous fumes can be generated when paint is heated by welding, soldering, or using a torch.

Do all work outside or in a well ventilated area. Dispose of paint and solvent properly.

Remove paint before welding or heating:

- If you sand or grind paint, avoid breathing the dust. Wear an approved respirator.
- If you use solvent or paint stripper, remove stripper with soap and water before welding. Remove solvent or paint stripper containers and other flammable material from area. Allow fumes to disperse at least 15 minutes before welding or heating.

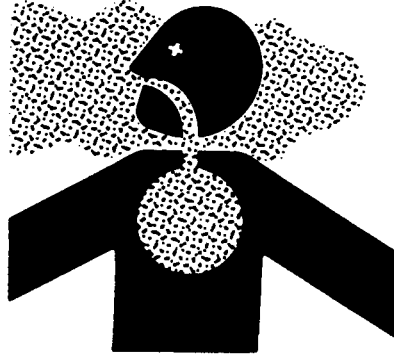

TS220 -UN-23AUG88

DX,PAINT -19-03MAR93-1/1

SERVICE COOLING SYSTEM SAFELY

Explosive release of fluids from pressurized cooling system can cause serious burns.

Shut off engine. Only remove filler cap when cool enough to touch with bare hands. Slowly loosen cap to first stop to relieve pressure before removing completely.

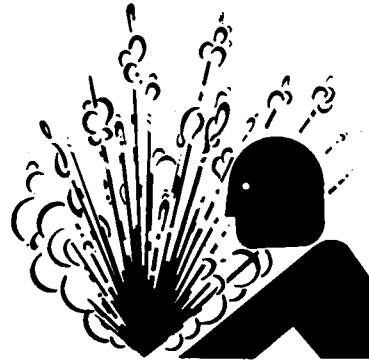

TS281 -UN-23AUG88

DX,RCAP -19-04JUN90-1/1

AVOID HARMFUL ASBESTOS DUST

Avoid breathing dust that may be generated when handling components containing asbestos fibers. Inhaled asbestos fibers may cause lung cancer.

Components in products that may contain asbestos fibers are brake pads, brake band and lining assemblies, clutch plates, and some gaskets. The asbestos used in these components is usually found in a resin or sealed in some way. Normal handling is not hazardous as long as airborne dust containing asbestos is not generated.

Avoid creating dust. Never use compressed air for cleaning. Avoid brushing or grinding material containing asbestos. When servicing, wear an approved respirator. A special vacuum cleaner is recommended to clean asbestos. If not available, apply a mist of oil or water on the material containing asbestos.

Keep bystanders away from the area.

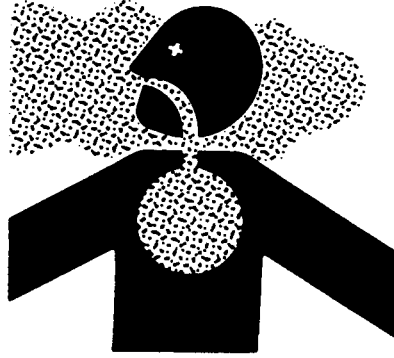

TS220 -UN-23AUG88

DX,DUST -19-15MAR91-1/1

DISPOSE OF WASTE PROPERLY

Improperly disposing of waste can threaten the environment and ecology. Potentially harmful waste used with John Deere equipment include such items as oil, fuel, coolant, brake fluid, filters, and batteries.

Use leakproof containers when draining fluids. Do not use food or beverage containers that may mislead someone into drinking from them.

Do not pour waste onto the ground, down a drain, or into any water source.

Air conditioning refrigerants escaping into the air can damage the Earth's atmosphere. Government regulations may require a certified air conditioning service center to recover and recycle used air conditioning refrigerants.

Inquire on the proper way to recycle or dispose of waste from your local environmental or recycling center, or from your John Deere dealer.

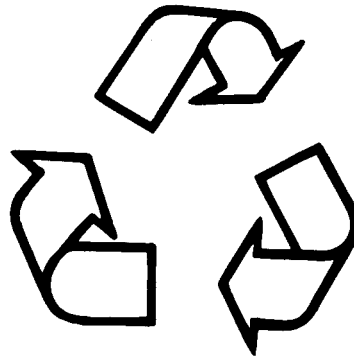

TS1133 -UN-26NOV90

DX,DRAIN -19-03MAR93-1/1

Fuels, Lubricants and Coolant

DIESEL FUEL

Consult your local fuel distributor for properties of the diesel fuel available in your area.

In general, diesel fuels are blended to satisfy the low temperature requirements of the geographical area in which they are marketed.

Diesel fuels specified to EN 590 or ASTM D975 are recommended.

In all cases, the fuel shall meet the following properties:

Cetane number of 40 minimum. Cetane number greater than 50 is preferred, especially for temperatures below -20°C (-4°F) or elevations above 1500 m (5,000 ft).

Cold Filter Plugging Point (CFPP) below the expected low temperature OR **Cloud Point** at least 5°C (9°F) below the expected low temperature.

Fuel lubricity should pass a minimum of 3100 gram load level as measured by the BOCLE scuffing test.

Sulfur content:

- Sulfur content should not exceed 0.5%. Sulfur content less than 0.05% is preferred.
- If diesel fuel with sulfur content greater than 0.5% sulfur content is used, reduce the service interval for engine oil and filter by 50%.
- DO NOT use diesel fuel with sulfur content greater than 1.0%.

Bio-diesel fuels may be used ONLY if the fuel properties meet DIN 51606 or equivalent specification.

DO NOT mix used engine oil or any other type of lubricant with diesel fuel.

DX,FUEL1 -19-17FEB99-1/1

HANDLING AND STORING DIESEL FUEL



CAUTION: Handle fuel carefully. Do not fill the fuel tank when engine is running.

DO NOT smoke while you fill the fuel tank or service the fuel system.

Fill the fuel tank at the end of each day's operation to prevent condensation and freezing during cold weather.

IMPORTANT: The fuel tank is vented through the filler cap. If a new filler cap is required, always replace it with an original vented cap.

When fuel is stored for an extended period or if there is a slow turnover of fuel, add a fuel conditioner to stabilize the fuel and prevent water condensation. Contact your fuel supplier for recommendations.

DX,FUEL4 -19-18MAR96-1/1

ENGINE BREAK-IN OIL

New engines are filled at the factory with John Deere ENGINE BREAK-IN OIL. During the break-in period, add John Deere ENGINE BREAK-IN OIL as needed to maintain the specified oil level.

Change the oil and filter after the first 100 hours of operation of a new or rebuilt engine.

After engine overhaul, fill the engine with John Deere ENGINE BREAK-IN OIL.

If John Deere ENGINE BREAK-IN OIL is not available, use a diesel engine oil meeting one of the following during the first 100 hours of operation:

- API Service Classification CE

- ACEA Specification E1

After the break-in period, use John Deere PLUS-50® or other diesel engine oil as recommended in this manual.

IMPORTANT: Do not use PLUS-50 oil or engine oils meeting API CG4, API CF4, ACEA E3, or ACEA E2 performance levels during the first 100 hours of operation of a new or rebuilt engine. These oils will not allow the engine to break-in properly.

PLUS-50 is a registered trademark of Deere & Company.

DX,ENOIL4 -19-10OCT97-1/1

DIESEL ENGINE OIL

Use oil viscosity based on the expected air temperature range during the period between oil changes.

The following oil is preferred:

- John Deere PLUS-50®

The following oil is also recommended:

- John Deere TORQ-GARD SUPREME TORQ-GARD SUPREME®

Other oils may be used if they meet one or more of the following:

- API Service Classification CG-4
- API Service Classification CF-4
- ACEA Specification E3
- ACEA Specification E2

Multi-viscosity diesel engine oils are preferred.

If diesel fuel with sulfur content greater than 0.5% is used, reduce the service interval by 50%.

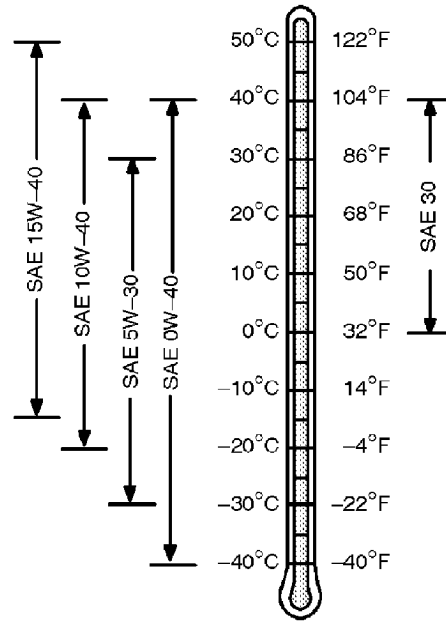

TS1661 -JUN-10OCT97

*PLUS-50 is a registered trademark of Deere & Company.
TORQ-GARD SUPREME is a trademark of Deere & Company*

CD,ENOIL -19-10OCT97-1/1

LUBRICANT STORAGE

Your equipment can operate at top efficiency only when clean lubricants are used.

Use clean containers to handle all lubricants.

Whenever possible, store lubricants and containers in an area protected from dust, moisture, and other contamination. Store containers on their side to avoid water and dirt accumulation.

Make certain that all containers are properly marked to identify their contents.

Properly dispose of all old containers and any residual lubricant they may contain.

DX,LUBST -19-18MAR96-1/1

MIXING OF LUBRICANTS

In general, avoid mixing different brands or types of oil. Oil manufacturers blend additives in their oils to meet certain specifications and performance requirements.

Mixing different oils can interfere with the proper functioning of these additives and degrade lubricant performance.

Consult your John Deere dealer to obtain specific information and recommendations.

DX,LUBMIX -19-18MAR96-1/1

DIESEL ENGINE COOLANT

The engine cooling system is filled to provide year-round protection against corrosion and cylinder liner pitting, and winter freeze protection to -37°C (-34°F).

John Deere COOL-GARD is preferred for service.

If John Deere COOL-GARD is not available, use a low silicate ethylene glycol base coolant concentrate in a 50% mixture of concentrate with quality water.

The coolant concentrate shall be of a quality that provides cavitation protection to cast iron and aluminum parts in the cooling system. John Deere COOL-GARD meets this requirement.

A 50% mixture of ethylene glycol engine coolant in water provides freeze protection to -37°C (-34°F). If protection at lower temperatures is required, consult your John Deere dealer for recommendations.

Water quality is important to the performance of the cooling system. Distilled, deionized, or demineralized

water is recommended for mixing with ethylene glycol base engine coolant concentrate.

IMPORTANT: Do not use cooling system sealing additives or antifreeze that contains sealing additives.

COOLANT DRAIN INTERVALS

Drain the factory fill engine coolant, flush the cooling system, and refill with new coolant after the first 3 years or 3000 hours of operation. Subsequent drain intervals are determined by the coolant used for service. At each interval, drain the coolant, flush the cooling system, and refill with new coolant.

When John Deere COOL-GARD is used, the coolant drain interval is 3 years or 3000 hours of operation.

If COOL-GARD is not used, the drain interval is reduced to 2 years or 2000 hours of operation.

DX.COOL8 -19-12FEB99-1/1

OPERATING IN WARM TEMPERATURE CLIMATES

John Deere engines are designed to operate using glycol base engine coolants.

Always use a recommended glycol base engine coolant, even when operating in geographical areas where freeze protection is not required.

IMPORTANT: *Water may be used as coolant in emergency situations only.*

Foaming, hot surface aluminum and iron corrosion, scaling, and cavitation will occur when water is used as the coolant, even when coolant conditioners are added.

Drain cooling system and refill with recommended glycol base engine coolant as soon as possible.

DX,COOL6 -19-18MAR96-1/1

Operating the Engine

BREAK-IN PERIOD

Within first 100 hours of operation

During the first 100 hours of operation, avoid overloading, excessive idling and no-load operation.

See ENGINE BREAK-IN OIL for eventual addition of oil.

NOTE: During the break-in period a higher-than-usual oil consumption should be considered as normal.

After first 100 hours of operation

After the first 100 hours, drain the crankcase and

change the oil filter (see CHANGING ENGINE OIL AND FILTER). Fill crankcase with seasonal viscosity grade oil (see DIESEL ENGINE OIL).

Check tension of alternator belt.

Check connections of air intake hoses.

Check for proper tightening of cap screws all around the engine.

DPSG,CD03523,17 -19-09JUL99-1/1

STARTING THE ENGINE



CAUTION: Before starting engine in a confined building, install proper outlet exhaust ventilation equipment. Always use safety approved fuel storage and piping.

NOTE: If temperature is below 0°C (32°F), it may be necessary to use cold weather starting aids (See COLD WEATHER OPERATION).

1. Perform all prestarting checks outlined in Maintenance/Daily Section.

2. Open the fuel supply shut-off valve, if equipped.

3. Activate the starter motor switch to crank the engine and release it as soon as engine starts.

NOTE: Do not operate the starter motor more than 20 seconds at a time.

DPSG,CD03523,18 -19-09JUL99-1/1

COLD WEATHER OPERATION

Depending on equipment, various cold weather starting aids are available to assist in starting the engine at temperatures below 0°C (32°F).

Continued on next page

DPSG,CD03523,19 -19-09JUL99-1/4

Air intake heater

Air intake heater is either a grid-type (A) for POWERTech engines or a glow plug-type (B) for 300-Series engines installed in the air intake channel.

⚠ CAUTION: NEVER use Ether Starting Fluid when air intake heater is used to start the engine.

Activate the heating element (preheater position) for 30 seconds maximum then start the engine.

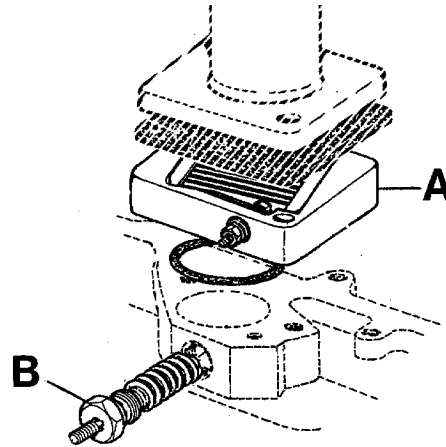

CD030750 -UN-03SEP99

DPSG,CD03523,19 -19-09JUL99-2/4

Coolant heater

Connect plug of coolant heater (A) to a power source (110 or 220 V).

At an ambient temperature of -15°C (5°F), the heating process takes approximately 2 hours. Extend heating period if ambient temperature is lower.

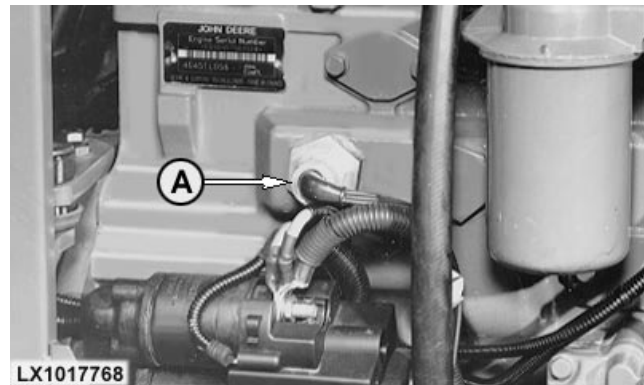

LX1017768

LX1017768 -UN-24OCT97

DPSG,CD03523,19 -19-09JUL99-3/4

Fuel preheater

Fuel preheater (A) switches ON and OFF automatically in relation to the ambient temperature.



LX1017708

LX1017708 -UN-09OCT97

DPSG,CD03523,19 -19-09JUL99-4/4

USING A BOOSTER BATTERY OR CHARGER

A 12-volt booster battery can be connected in parallel with battery(ies) on the unit to aid in cold weather starting. ALWAYS use heavy duty jumper cables.

CAUTION: Gas given off by batteries is explosive. Keep sparks and flames away from batteries. Before connecting or disconnecting a battery charger, turn charger off. Make last connection and first disconnection at a point away from battery. Always connect **NEGATIVE (-)** cable last and disconnect this cable first.

IMPORTANT: Be sure polarity is correct before making connections. Reversed polarity will damage electrical system. Always connect positive to positive and negative to ground. Always use 12-volt booster battery for 12-volt electrical systems and 24-volt booster battery/batteries for 24-volt electrical systems.

1. Connect booster battery or batteries to produce the required system voltage for your engine application.

NOTE: To avoid sparks, DO NOT allow the free ends of jumper cables to touch the engine.

2. Connect one end of jumper cable to the **POSITIVE (+)** post of the booster battery.
3. Connect the other end of the jumper cable to the **POSITIVE (+)** post of battery connected to starter.
4. Connect one end of the other jumper cable to the **NEGATIVE (-)** post of the booster battery.
5. ALWAYS complete the hookup by making the last connection of the **NEGATIVE (-)** cable to a good ground on the engine frame and away from the battery(ies).
6. Start the engine. Disconnect jumper cables immediately after engine starts. Disconnect **NEGATIVE (-)** cable first.

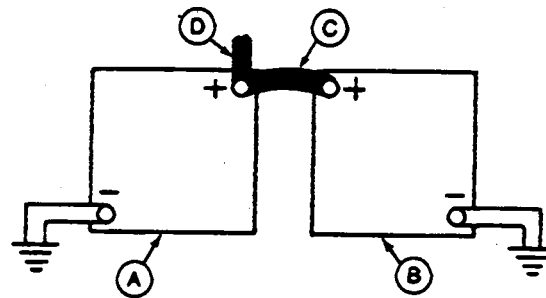

12-Volt System

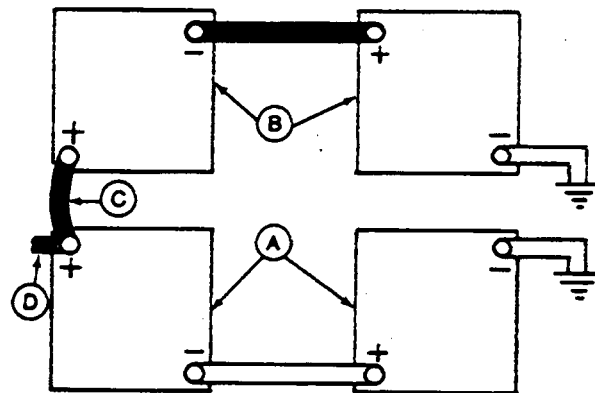

24-Volts System

A—12-Volt Machine battery/batteries
 B—12-Volt Booster battery/batteries
 C—Booster cable
 D—Cable to starter motor

TS204 -UN-23AUG88

RG4678 -UN-14DEC88

RG4688 -UN-14DEC88

ENGINE OPERATION

Warming engine

Operate engine at high idle for 1 to 2 minutes before applying the load.

NOTE: This procedure does not apply to standby generator sets where the engine is loaded immediately upon reaching rated speed.

Normal engine operation

Compare engine coolant temperature and engine oil pressure with specifications below:

Minimum oil pressure at full load rated speed¹—Specification

Pressure..... 275 kPa (2.75 bar; 40 psi)

Coolant temperature range—Specification

Temperature 82°—94°C (180°—202°F)

Stop engine immediately if coolant temperature is above or oil pressure below specifications or if there are any signs of part failure. Symptoms that may be early signs of engine problems could be:

- Sudden loss of power

- Unusual noise or vibration
- Excessive black exhaust fumes
- Excessive fuel consumption
- Excessive oil consumption
- Fluid leaks

Recommendation for turbocharger engines

Should the engine stall when operating under load, IMMEDIATELY restart it to prevent overheating of turbocharger components.

Idling engine

Avoid excessive engine idling. Prolonged idling may cause the engine coolant temperature to fall below its normal range. This, in turn, causes crankcase oil dilution, due to incomplete fuel combustion, and permits formation of gummy deposits on valves, pistons and piston rings. It also promotes rapid accumulation of engine sludge and unburned fuel in the exhaust system. If an engine will be idling for more than 5 minutes, stop and restart later.

NOTE: Generator set applications have the governor locked at a specified speed and do not have a slow idle function. These engines idle at no load governed speed (fast idle).

¹Oil at normal operating temperature of 115°C (240°F).

STANDBY POWER UNITS

To assure that your engine will deliver efficient standby operation when needed, start engine and run at rated speed (with 50%—70% load) for 30 minutes every

2 weeks. DO NOT allow engine to run an extended period of time with no load.

STOPPING THE ENGINE

1. Before stopping, run engine for at least 2 minutes at fast idle and no load.
2. Stop the engine.

DPSG.CD03523,23 -19-09JUL99-1/1

Maintenance

OBSERVE SERVICE INTERVALS

Using hour meter as a guide, perform all services at the hourly intervals indicated on following pages. At each scheduled maintenance interval, perform all previous maintenance operations in addition to the ones specified. Keep a record of hourly intervals and services performed using charts provided in Maintenance Records Section.

IMPORTANT: Recommended service intervals are for normal operating conditions. Service **MORE OFTEN** if engine is operated under adverse conditions. Neglecting maintenance can result in failures or permanent damage to the engine.

DPSG.CD03523,24 -19-09JUL99-1/1

USE CORRECT FUELS, LUBRICANTS AND COOLANT

IMPORTANT: Use only fuels, lubricants, and coolants meeting specifications outlined in Fuels, Lubricants, and Coolant Section when servicing your John Deere Engine.

Consult your John Deere engine distributor, servicing dealer or your nearest John Deere Parts Network for recommended fuels, lubricants, and coolant. Also available are necessary additives for use when operating engines in tropical, arctic, or any other adverse conditions.



TS100 -JUN-23AUG88

DPSG.CD03523,25 -19-09JUL99-1/1

MAINTENANCE INTERVAL CHART

Item	10 H / daily	500 H	1000 H / 1 year	2000 H / 2 years	2500 H / 3 years	As required
Check engine oil and coolant level	•					
Check air filter restriction indicator ^a	•					
Change engine oil and filter ^b		•				
Replace fuel filter element		•				
Check belt tension and automatic tensioner ^c		•	•			
Check and adjust valve clearance ^d			•	•		
Clean crankcase vent tube			•			
Check air intake hoses, connections and system			•			
Check vibration damper (6 cyl.) ^e				•		
Check engine speed and speed droop governor				•		
Drain and flush cooling system ^f				•	•	
Drain water and sediment from fuel filter						•
Clean filter element (see note a)						•
Test thermostat and injection nozzles (see your dealer) ^g						•

^aClean air filter element when restriction indicator is red. Replace filter element after 6 cleanings or once a year.

^bChange oil and filter after the first 100 hours of operation, then every 500 hours thereafter. Change oil and filter at least once a year.

^cCheck belt tension every 500 hours on 300-Series engines and on POWERTech engines with manual tensioner. Check automatic belt tensioner every 1000 hours/1 year on POWERTech engines when equipped.

^dHave your authorized servicing dealer or engine distributor adjust valve clearance as follows. After the first 500 hours of operation then every 1000 hours thereafter on 300-Series engines. Every 2000 hours on POWERTech engines.

^eHave your authorized dealer or engine distributor replace the vibration damper every 4500 hours/5 years.

^fDrain and flush cooling system every 2500 hours/3 years when John Deere COOL-GARD coolant is used. Otherwise every 2000 hours/2 years.

^gContact your dealer when thermostat or injection nozzles are suspected to be defective. Replace injection nozzles every 5000 hours and thermostat every 10000 hours.

Maintenance/Daily or every 10 hours

DAILY PRESTARTING CHECKS

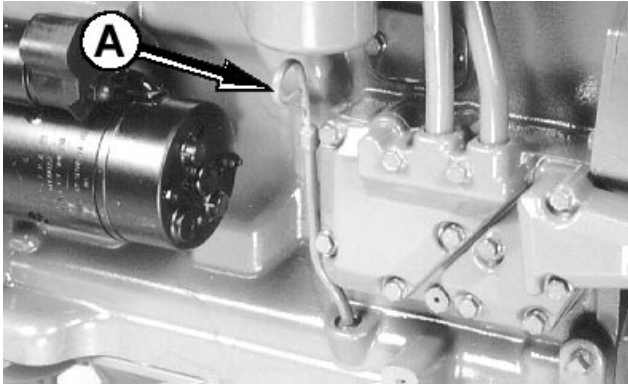

CD30753 -UN-26AUG99

POWERTech engine

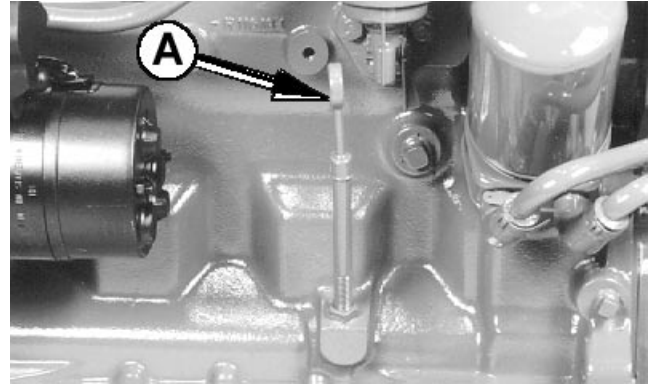

CD30754 -UN-26AUG99

300-Series engine

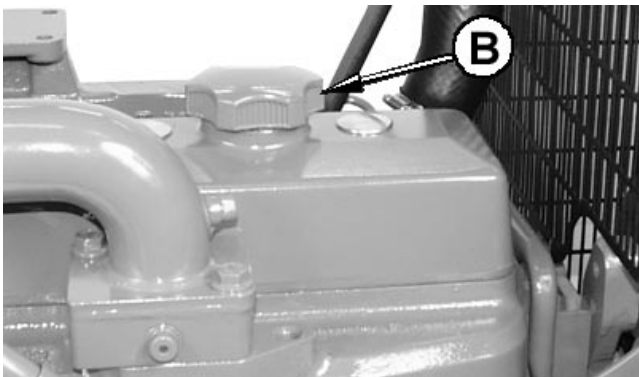

CD30755 -UN-24SEP99

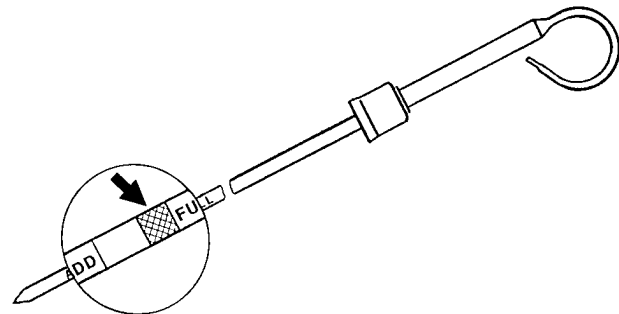

FD000047

FD000047 -UN-13MAR96

Do the following BEFORE STARTING THE ENGINE for the first time each day:

IMPORTANT: DO NOT top up with fresh oil until the oil level is BELOW the add mark.

1. Check engine oil level on dipstick (A). Add as required, using seasonal viscosity grade oil. (See

DIESEL ENGINE OIL). Add oil at rocker arm cover filler cap (B).

IMPORTANT: DO NOT fill above the crosshatch area. Oil levels anywhere within crosshatch are considered in the acceptable operating range.

Continued on next page

DPSG,CD03523,27 -19-12JUL99-1/3



TS281 -UN-23AUG88

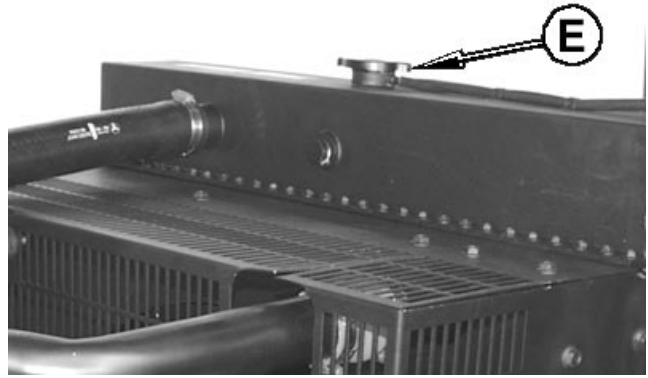

CD30756 -UN-26AUG99

2. **CAUTION:** Explosive release of fluids from pressurized cooling system can cause serious burns.

Only remove filler cap when engine is cold or when cool enough to touch with bare hands. Slowly loosen cap to first stop to relieve pressure before removing completely.

Remove radiator cap (E) and check coolant level which should be at bottom of filler neck. Fill radiator with proper coolant solution if level is low. (See DIESEL ENGINE COOLANT). Check overall cooling system for leaks.

DPSG,CD03523,27 -19-12JUL99-2/3

3. If air filter has a dust unloading valve (C), squeeze valve tip to release any trapped dirt particles.
4. Check air intake restriction indicator (D). When indicator is red, air filter needs to be cleaned.

IMPORTANT: Maximum air intake restriction is 6.25 kPa (0.06 bar; 1.0 psi) (25 in. H₂O). A clogged air cleaner element will cause excessive intake restriction and a reduced air supply to the engine.

5. Make a thorough inspection of the engine compartment.

NOTE: Wipe all fittings, caps and plugs before performing any maintenance to reduce the chance of system contamination.

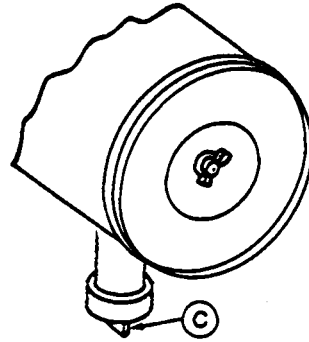

RG4887 -UN-20DEC88



CD30757 -UN-26AUG99

DPSG,CD03523,27 -19-12JUL99-3/3

Maintenance/500 hours

CHANGING ENGINE OIL AND FILTER

NOTE: Change engine oil and filter for the first time after 100 hours maximum of operation, then every 500 hours thereafter. Change oil and filter at least once a year.

1. Run engine approximately 5 minutes to warm up oil. Shut engine off.
2. Open oil pan drain valve (A).
3. Drain crankcase oil from engine while warm.
4. Remove and discard oil filter element (B) using a suitable filter wrench.
5. Remove oil filter packing and clean filter mounting pad.

IMPORTANT: Filtration of oils is critical to proper lubrication. Always change filter regularly. Use filters meeting John Deere performance specifications.

6. Oil the new packing and install a new filter element. Hand tighten element according to values printed on filter element. If values are not provided, tighten element approximately 3/4 — 1-1/4 turn after packing contacts filter housing. DO NOT overtighten filter element.
7. Close oil pan drain valve.

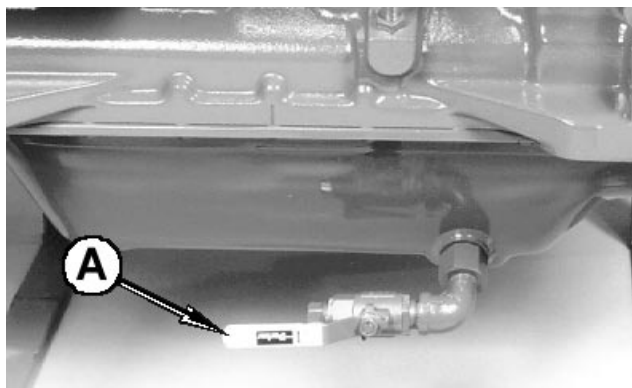

CD30758 -UN-26AUG99

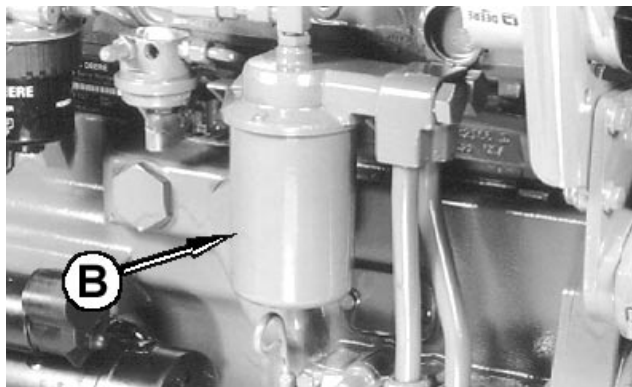

CD30759 -UN-26AUG99

POWERTEch engine

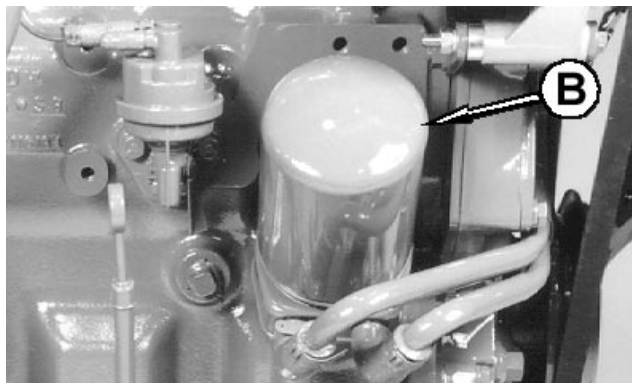

CD30760 -UN-26AUG99

300-Series engine

Continued on next page

DPSG,CD03523,29 -19-12JUL99-1/2

8. Fill engine crankcase with correct John Deere engine oil through rocker arm cover opening (C); see DIESEL ENGINE OIL.

To determine the correct oil fill quantity for your engine, see "Engine Oil Quantities" in Specifications Section.

NOTE: Crankcase oil capacity may vary slightly. ALWAYS fill crankcase to full mark or within crosshatch on dipstick, whichever is present. DO NOT overfill.

IMPORTANT: Immediately after completing any oil change, crank engine for 30 seconds without permitting engine to start. This will help insure adequate lubrication to engine components before engine starts.

9. Start engine and run to check for possible leaks.
10. Stop engine and check oil level after 10 minutes. If necessary, top up.

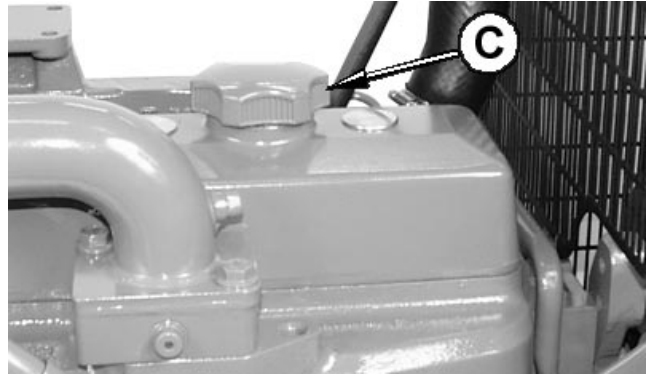

CD30761 -UN-24SEP99

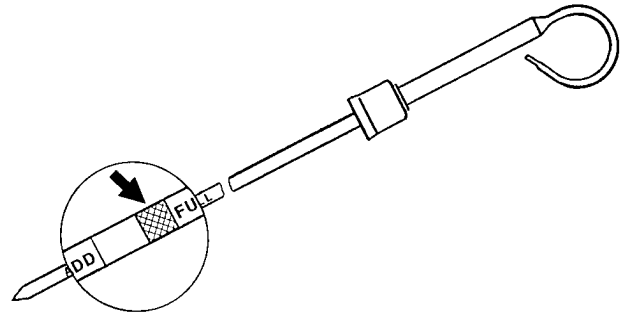

FD000047

FD000047 -UN-13MAR96

DPSG.CD03523.29 -19-12JUL99-2/2

REPLACING FUEL FILTER ELEMENT

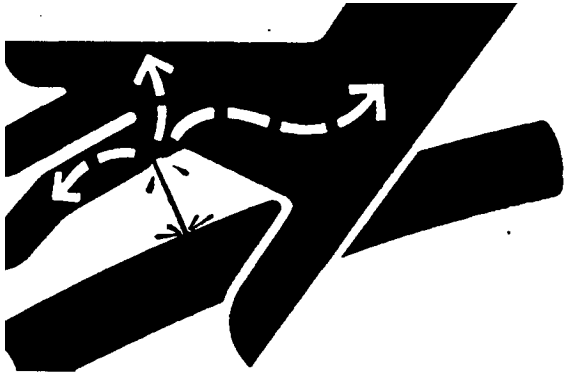

X9811 -UN-23AUG88

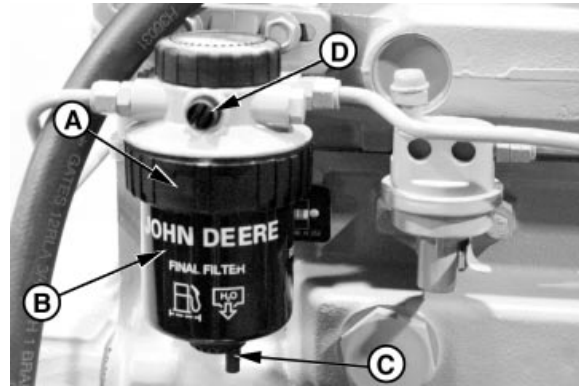

RG7721 -UN-15JAN99

A—Retaining ring

B—Filter element

C—Drain plug

D—Bleed plug

! **CAUTION: CAUTION:** Escaping fluid under pressure can penetrate the skin causing serious injury. Relieve pressure before disconnecting fuel or other lines. Tighten all connections before applying pressure. Keep hands and body away from pinholes and nozzles which eject fluids under high pressure. Use a piece of cardboard or paper to search for leaks. Do not use your hand.

If any fluid is injected into the skin, it must be surgically removed within a few hours by a doctor familiar with this type injury or gangrene may result. Doctors unfamiliar with this type of injury may call the Deere & Company Medical Department in Moline, Illinois, or other knowledgeable medical source.

1. Thoroughly clean fuel filter assembly and surrounding area.
2. Loosen drain plug (C) and drain fuel into a suitable container.

NOTE: Lifting up on retaining ring as it is rotated helps to get it past raised locators.

3. Firmly grasp the retaining ring (A) and rotate it clockwise 1/4 turn. Remove ring with filter element (B).

IMPORTANT: Do not dump the old fuel into the new filter element. This could cause fuel injection problem.

A plug is provided with the new element for plugging the used element.

4. Inspect filter mounting base for cleanliness. Clean as required.

NOTE: Raised locators on fuel filter canister must be indexed properly with slots in mounting base for correct installation.

5. Install new filter element dry onto mounting base. Be sure element is properly indexed and firmly seated on base. It may be necessary to rotate filter for correct alignment.

6. Install retaining ring onto mounting base making certain dust seal is in place on filter base. Hand tighten ring (about 1/3 turn) until it “snaps” into the detent. DO NOT overtighten retaining ring.

NOTE: The proper installation is indicated when a “click” is heard and a release of the retaining ring is felt.

7. Bleed the fuel system.

CHECKING BELT (300-SERIES ENGINES)

1. Inspect belt for cracks, fraying, or stretched out areas. Replace as necessary.
2. Check belt tension using one of following methods:

a) Use of JDG529 Tension Gauge (A)

Belt tension—Specification

New belt..... 578—622 N (130—140 lb-force)
Used belt 378—423 N (85—94 lb-force)

NOTE: Belt is considered used after 10 minutes of operation.

b) Use of tension tester (B) and straight edge (C)

A 89 N (20 lb) force applied halfway between pulleys should deflect belt by 19 mm (0.75 in.).

3. If adjustment is necessary, loosen alternator nuts (D) and (E). Pull alternator frame outward until belt is correctly tensioned.

IMPORTANT: Do not pry against the alternator rear frame. Do not tighten or loosen belts while they are hot.

4. Tighten alternator bracket nuts firmly.
5. Run engine for 10 minutes then recheck belt tension.

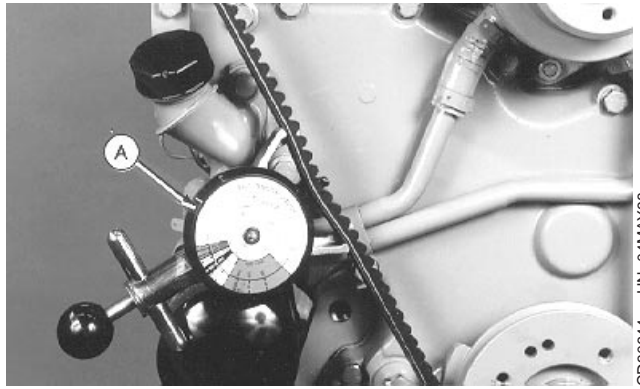

CD30644 -UN-04MAY98

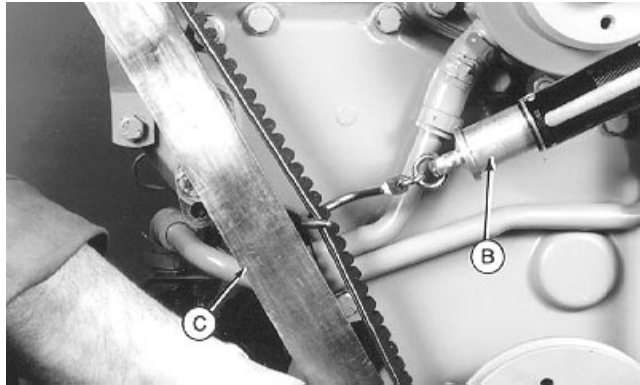

CD30645 -UN-04MAY98

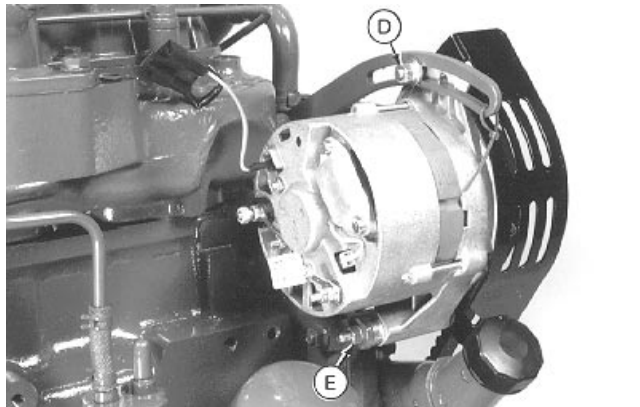

CD30646 -UN-04MAY98

CHECKING BELT (POWERTECH ENGINES WITH MANUAL TENSIONER)

Inspect belt for cracks, fraying, or stretched out areas. Replace if necessary.

NOTE: Belt adjustment is measured using a gauge stamped on the top edge of the alternator bracket.

1. Loosen cap screws (B) and (C).
2. Slide alternator in slot by hand to remove all excess slack in belt.

IMPORTANT: Do not pry against alternator rear frame.

3. Using the gauge (A) on the alternator bracket, stretch belt by prying outward on alternator front frame. Stretch the belt 1 gauge unit for a used belt and 1.5 gauge units for a new belt.
4. Tighten cap screws (B) and (C).

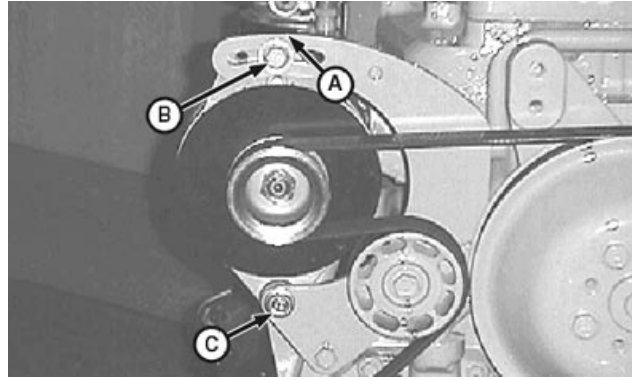

RG9132 -UN-04OCT99

A—Belt gauge
B—Cap screw
C—Cap screw

DPSG,CD03523,57 -19-16AUG99-1/1

Maintenance/1000 hours/1 year

CLEANING CRANKCASE VENT TUBE

If you operate the engine in dusty conditions, clean the tube at shorter intervals.

1. Remove and clean crankcase vent tube (A).
2. Install the vent tube. Be sure the O-ring fits correctly in the rocker arm cover bore for elbow adapter. Tighten hose clamp securely.

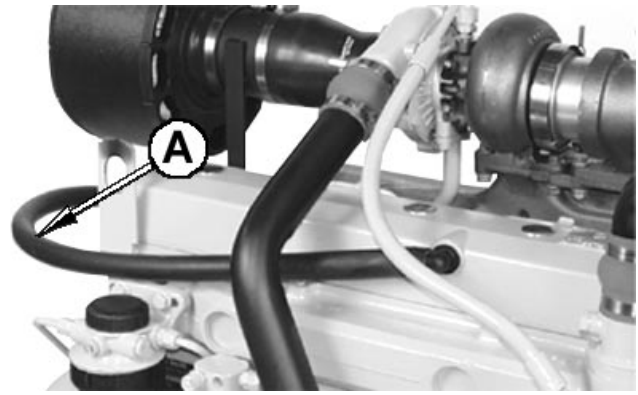

DPSG,CD03523,32 -19-12JUL99-1/1

CHECKING AIR INTAKE SYSTEM

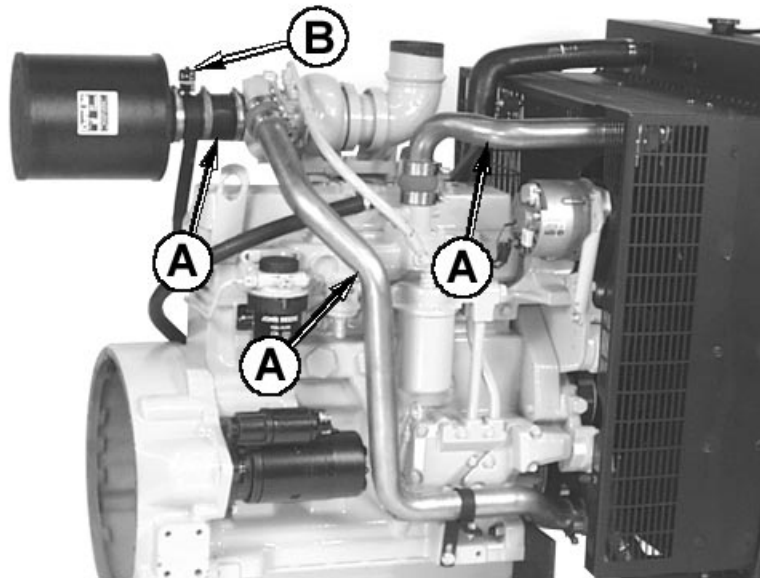

IMPORTANT: The air intake system must not leak. Any leak, no matter how small, may result in engine failure due to abrasive dirt and dust entering the intake system.

1. Inspect all intake hoses (piping) for cracks. Replace as necessary.

2. Check clamps on piping (A) which connect the air filter, engine and, if present, turbocharger and air-to-air radiator. Tighten clamps as necessary.
3. Test air restriction indicator (B) for proper operation. Replace indicator as necessary.

Continued on next page

DPSG,CD03523,33 -19-12JUL99-1/2

4. If engine has a rubber dust unloading valve (C), inspect the valve on bottom of air filter for cracks or plugging. Replace as necessary.
5. Service air filter as necessary.

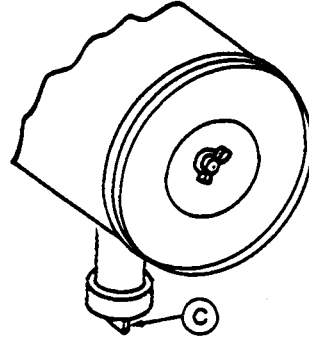

DPSG.CD03523,33 -19-12JUL99-2/2

RG4687 -UN-20DEC88

CHECKING AUTOMATIC BELT TENSIONER (POWERTECH ENGINES)

Belt drive systems equipped with automatic (spring) belt tensioners cannot be adjusted or repaired. The automatic belt tensioner is designed to maintain proper belt tension over the life of the belt. If tensioner spring tension is not within specification, replace tensioner assembly.

- **Checking belt wear**

The belt tensioner is designed to operate within the limit of arm movement provided by the cast stops (A) and (B) when correct belt length and geometry is used. If the tensioner stop on swing arm (A) is hitting the fixed stop (B), check mounting brackets (alternator, belt tensioner, idler pulley, etc.) and the belt length. Replace belt as needed (see REPLACING FAN AND ALTERNATOR BELTS).

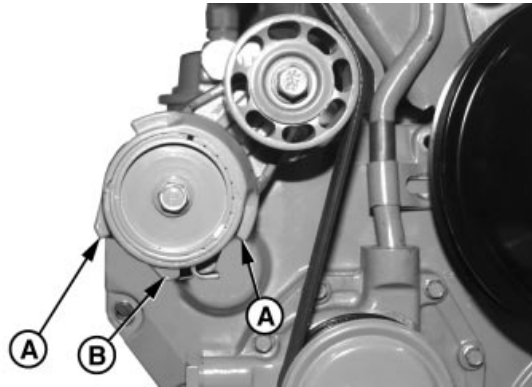

RG8098 -UN-18NOV97

Continued on next page

DPSG.CD03523,34 -19-13JUL99-1/2

• **Checking tensioner spring tension**

A belt tension gauge will not give an accurate measure of the belt tension when automatic spring tensioner is used. Measure tensioner spring tension using a torque wrench and procedure outlined below:

- a. Release tension on belt using a breaker bar and socket on tension arm. Remove belt from pulleys.
- b. Release tension on tension arm and remove breaker bar.
- c. Put a mark (A) on swing arm of tensioner as shown.
- d. Measure 21 mm (0.83 in.) from (A) and put a mark (B) on tensioner mounting base.
- e. Rotate the swing arm using a torque wrench until marks (A) and (B) are aligned.
- f. Record torque wrench measurement and compare with specification below. Replace tensioner assembly as required.

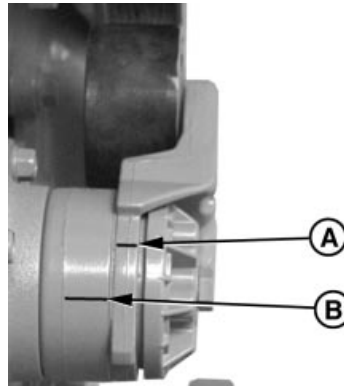

RG7977 -UN-14NOV97

Spring—Specification

Force..... 18—22 N•m (13—16 lb-ft)

DPSG.CD03523,34 -19-13JUL99-2/2

CHECK AND ADJUST ENGINE VALVE CLEARANCE (300-SERIES ENGINES)

NOTE: Valve clearance must be adjusted after the first 500 hours of operation, then every 1000 hours thereafter.

Adjust engine valve clearance as follows or have your authorized servicing dealer or engine distributor adjust the engine valve clearance.

- 1. Remove rocker arm cover and crankcase vent tube.
- 2. Using JDE83 or JDG820 Flywheel Turning Tool (A), rotate engine flywheel in running direction (clockwise viewed from water pump) until No.1 piston (front) has reached top dead center (TDC) on compression stroke. Insert timing pin JDE81-4 (B) into flywheel bore.

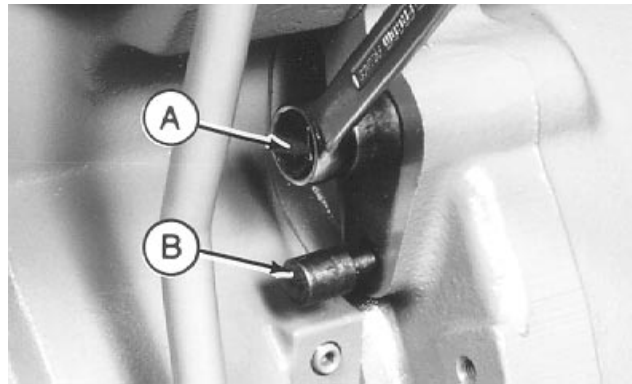

CD30544 -UN-19MAY98

Continued on next page

DPSG.CD03523,35 -19-13JUL99-1/4

3. Check and adjust valve clearance to specifications according to following procedures.

Valve clearance (engine cold)—Specification

Intake.....	0.35 mm (0.014 in.)
Exhaust.....	0.45 mm (0.018 in.)

NOTE: If rocker arm is equipped with adjusting screw and lock nut (A), tighten lock nut to 27 N•m (20 lb-ft) after adjusting valve clearance.

4. Reinstall rocker arm cover and crankcase vent tube.

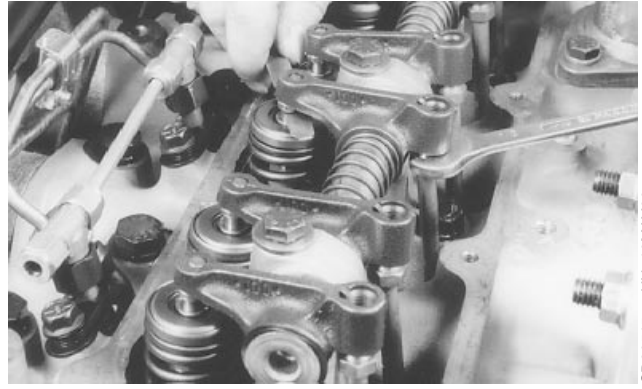

CD30545 -UN-19MAY98

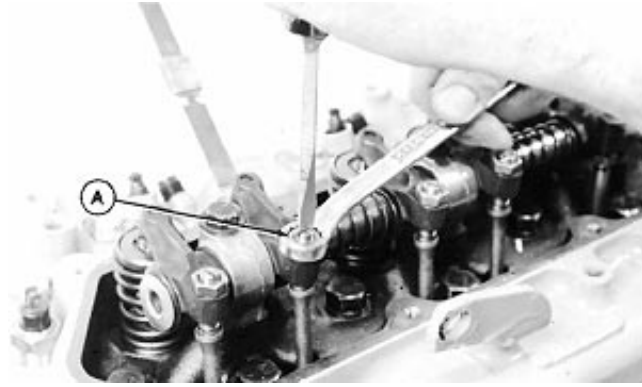

RG6307 -UN-03AUG82

DPSG.CD03523,35 -19-13JUL99-2/4

• 3-Cylinder Engine:

NOTE: Firing order is 1-2-3.

- a. Lock No. 1 piston at TDC compression stroke (D).
- b. Adjust valve clearance on No. 1 and 2 exhaust valves and No.1 and 3 intake valves.
- c. Rotate flywheel 360°. Lock No. 1 piston at TDC exhaust stroke (E).
- d. Adjust valve clearance on No. 3 exhaust valve and No. 2 intake valve.

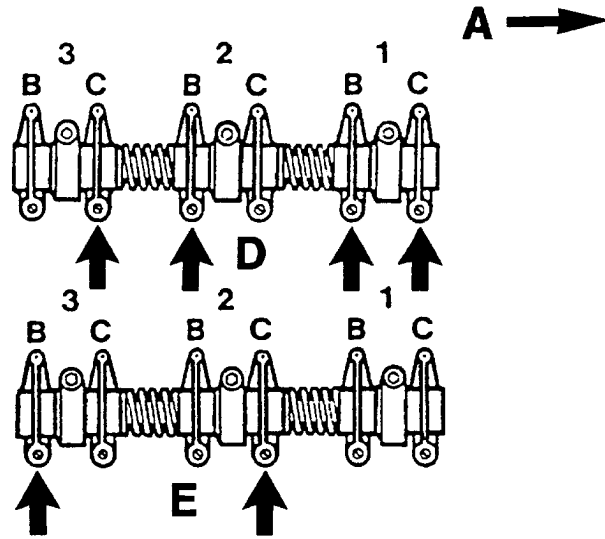

CD30549 -UN-16JUN98

- A—Front of engine
- B—Exhaust valve
- C—Intake valve
- D—No.1 Piston at TDC compression stroke
- E—No.1 Piston at TDC exhaust stroke

Continued on next page

DPSG.CD03523,35 -19-13JUL99-3/4

• **4-Cylinder Engine:**

NOTE: Firing order is 1-3-4-2.

- a. Lock No. 1 piston at TDC compression stroke (B).
- b. Adjust valve clearance on No. 1 and 3 exhaust valves and No.1 and 2 intake valves.
- c. Rotate flywheel 360°. Lock No. 4 piston at TDC compression stroke (C).
- d. Adjust valve clearance on No. 2 and 4 exhaust valves and No. 3 and 4 intake valves.

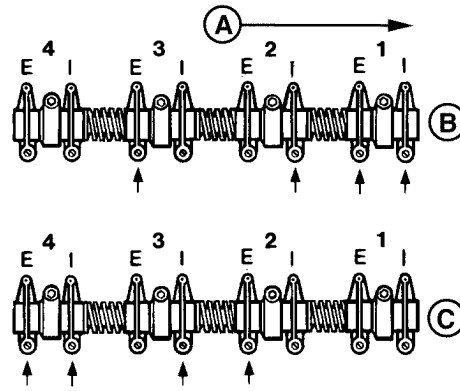

A—Front of engine
 B—No.1 Piston at TDC compression stroke
 C—No.4 Piston at TDC compression stroke
 E—Exhaust valve
 I—Intake valve

RG4776 -UN-31OCT97

Maintenance/2000 hours/2 years

CHECK AND ADJUST ENGINE VALVE CLEARANCE (POWERTECH ENGINE)

Adjust engine valve clearance as follows or have your authorized servicing dealer or engine distributor adjust the engine valve clearance.

1. Remove rocker arm cover and crankcase vent tube.
2. Using JDE83 or JDG820 Flywheel Turning Tool (A), rotate engine flywheel in running direction (clockwise viewed from water pump) until No.1 piston (front) has reached top dead center (TDC) on compression stroke. Insert timing pin JDE81-4 (B) into flywheel bore.

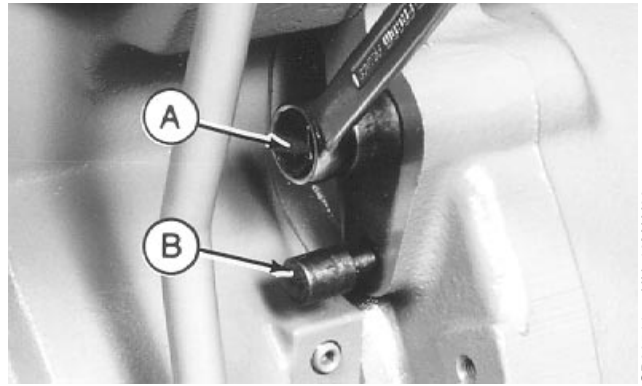

CD30544 -UN-19MAY98

DPSG,CD03523,36 -19-13JUL99-1/4

3. Check and adjust valve clearance to specifications according to following procedures.

Valve clearance (engine cold)—Specification

Intake 0.35 mm (0.014 in.)
Exhaust..... 0.45 mm (0.018 in.)

4. If valves need adjusting, loosen the lock nut on rocker arm adjusting screw. Turn adjusting screw until feeler gauge slips with a slight drag. Hold the adjusting screw from turning with screwdriver and tighten lock nut to 27 N•m (20 lb-ft). Recheck clearance again after tightening lock nut. Readjust clearance as necessary.
5. Reinstall rocker arm cover and crankcase vent tube.

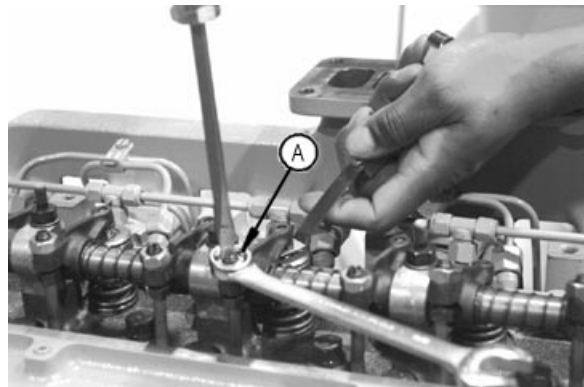

RG7409 -UN-06AUG96

Continued on next page

DPSG,CD03523,36 -19-13JUL99-2/4

• **4-Cylinder Engine:**

NOTE: Firing order is 1-3-4-2.

- Lock No. 1 piston at TDC compression stroke (B).
- Adjust valve clearance on No. 1 and 3 exhaust valves and No.1 and 2 intake valves.
- Rotate flywheel 360°. Lock No. 4 piston at TDC compression stroke (C).
- Adjust valve clearance on No. 2 and 4 exhaust valves and No. 3 and 4 intake valves.

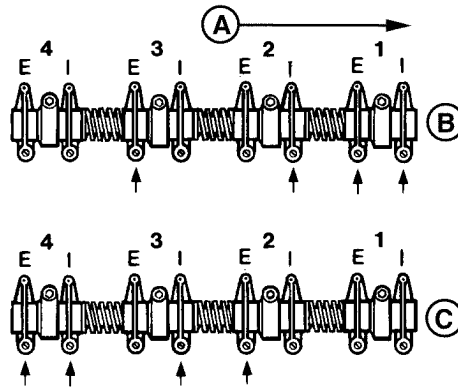

A—Front of engine
 B—No.1 Piston at TDC compression stroke
 C—No.4 Piston at TDC compression stroke
 E—Exhaust valve
 I—Intake valve

RG4776 -UN-31OCT97

DPSG.CD03523,36 -19-13JUL99-3/4

• **6-Cylinder Engine:**

NOTE: Firing order is 1-5-3-6-2-4.

- Lock No. 1 piston at TDC compression stroke (B).
- Adjust valve clearance on No. 1, 3, and 5 exhaust valves and No. 1, 2, and 4 intake valves.
- Rotate flywheel 360°. Lock No. 6 piston at TDC compression stroke (C).
- Adjust valve clearance on No. 2, 4, and 6 exhaust valves and No. 3, 5, and 6 intake valves.

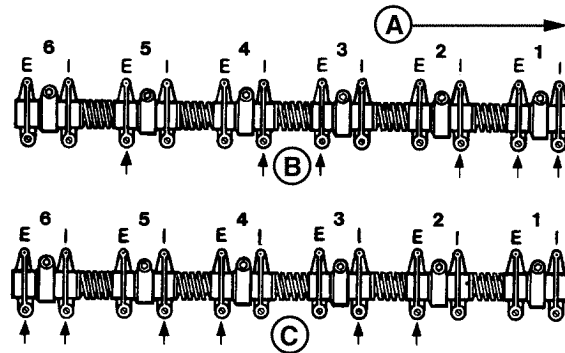

A—Front of engine
 B—No.1 Piston at TDC compression stroke
 C—No.6 Piston at TDC compression stroke
 E—Exhaust valve
 I—Intake valve

RG4777 -UN-31OCT97

DPSG.CD03523,36 -19-13JUL99-4/4

CHECKING ENGINE SPEED

NOTE: Most engines for generator set application (1500 rpm for 50 Hz or 1800 rpm for 60 Hz) run only at fast idle and therefore they do not have slow idle.

Fast idle—Specification

50 Hz Generator set.....	1550—1580 rpm
60 Hz Generator set.....	1865—1890 rpm

NOTE: Fast idle is settled by the factory then the idle adjusting screw (A) is sealed to prevent from tampering. Fast idle adjustment can only be done by an authorized fuel system agent.

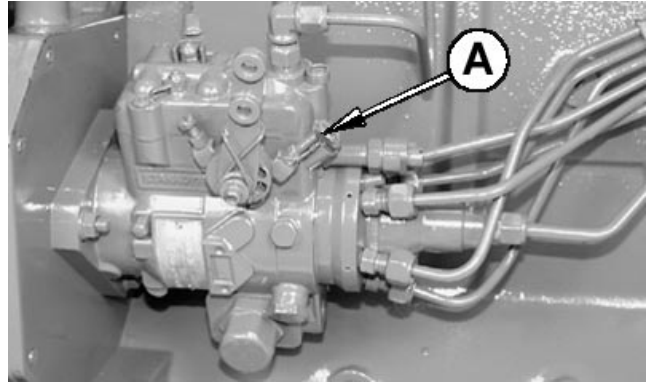

CD30763 -UN-24SEP99

DPSG,CD03523,38 -19-13JUL99-1/1

ADJUST SPEED DROOP GOVERNOR

1. Warm engine to normal operating temperature.
2. Run engine at fast idle.
3. Apply full load.
4. If specified power cannot be obtained, turn screw (B) to adjust droop until the requested power is reached.

NOTE: If surging exists upon removing the load, turn screw (B) clockwise to eliminate.

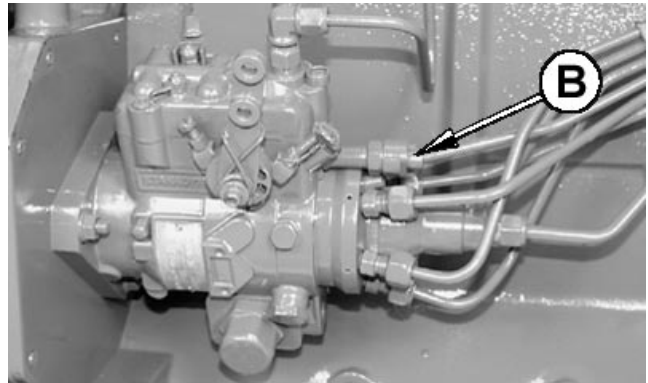

CD30764 -UN-24SEP99

DPSG,CD03523,39 -19-13JUL99-1/1

CHECKING CRANKSHAFT VIBRATION DAMPER (6-CYLINDER ENGINE ONLY)

1. Remove belts (shown removed).
2. Grasp vibration damper with both hands and attempt to turn it in both directions. If rotation is felt, damper is defective and should be replaced.

IMPORTANT: The vibration damper assembly is not repairable and should be replaced every 4500 hours or 5 years, whichever occurs first.

3. Check vibration damper radial runout by positioning a dial indicator so probe contacts damper outer circumference.
4. With engine at operating temperature, rotate crankshaft using JDG820 or JDE83 Flywheel Turning Tool.
5. Note dial indicator reading. If runout exceeds specifications given below, replace vibration damper.

Damper—Specification

Maximum radial runout..... 1.50 mm (0.060 in.)

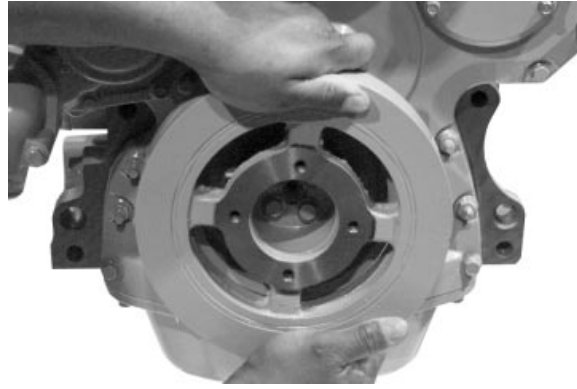

RG8018 -UN-15JAN99

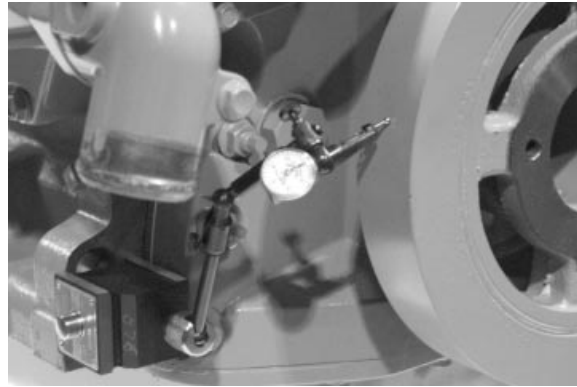

RG7608 -UN-23NOV97

Maintenance/2500 hours/3 years

DRAIN AND FLUSH COOLING SYSTEM

NOTE: Drain and flush cooling system every 2500 hours/3 years when John Deere COOL-GARD coolant is used. Otherwise every 2000 hours/2 years.

CAUTION: Explosive release of fluids from pressurized cooling system can cause serious burns.

Shut off engine. Only remove filler cap when cool enough to touch with bare hands. Slowly loosen cap to first stop to relieve pressure before removing completely.

1. Slowly open the radiator cap.
2. Remove engine block drain plug (A).
3. On POWERTech engines, remove oil cooler housing drain plug (B).
4. Open radiator drain valve (C). Drain all coolant from radiator.
5. Close all drain orifices after coolant has drained.
6. Fill the cooling system with clean water. Run engine until water passes through the thermostat to stir up possible rust or sediment.
7. Stop engine and immediately drain the water from system before rust and sediment settle.
8. After draining water, close all drain orifices and fill the cooling system with clean water and TY15979 John Deere Heavy Duty Cooling System Cleaner or equivalent cleaner. Follow manufacturer's directions on label.
9. After cleaning the cooling system, drain cleaner and fill with water to flush the system. Run engine until water passes through the thermostat, then drain out flushing water.

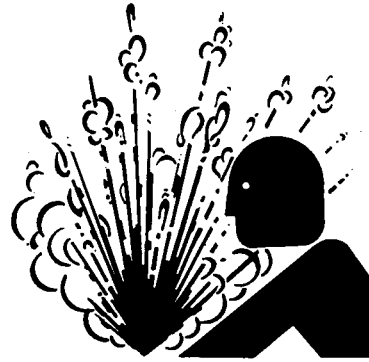

TS281 -UN-23AUG88

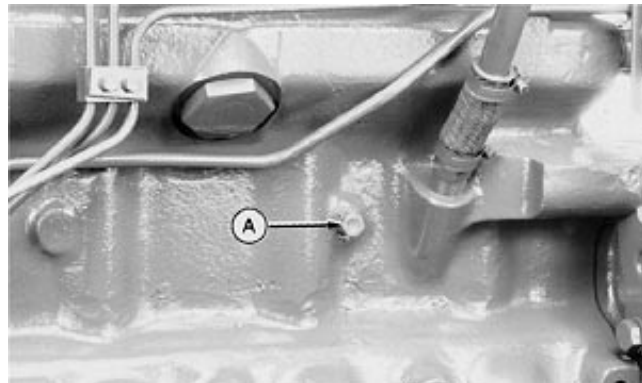

RG4894 -UN-14DEC88

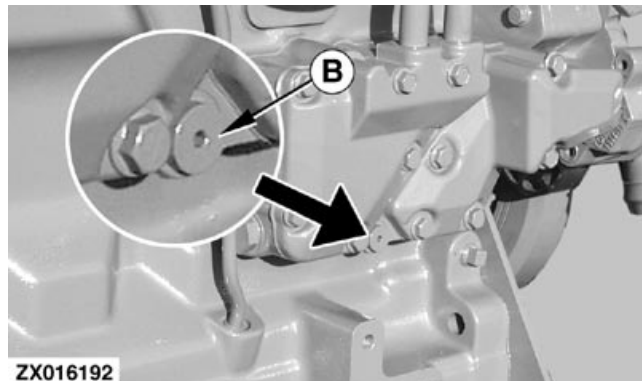

ZX016192

ZX016192 -UN-11JAN89



CD30765 -UN-27AUG99

Continued on next page

DPSG.CD03523.41 -19-13JUL99-1/3

10. Check cooling system hoses for proper condition.
Replace as necessary.

11. Close all drain orifices and fill the cooling system with specified coolant (see DIESEL ENGINE COOLANT).

Cooling system capacity—Specification

CD3029DF128.....	14.5 L (15.5 qt)
CD4039DF008.....	16.5 L (17.5 qt)
CD4039TF008.....	16.5 L (17.5 qt)
CD4045DF158.....	20 L (21 qt)
CD4045HF158.....	25 L (26.5 qt)
CD4045TF158.....	25 L (26.5 qt)
CD4045TF258.....	25 L (26.5 qt)
CD6068HF158.....	29 L (30.5 qt)
CD6068TF158.....	26 L (27.5 qt)
CD6068TF258.....	26 L (27.5 qt)

DPSG,CD03523,41 -19-13JUL99-2/3

12. When refilling cooling system, loosen temperature sensor (B) or plug at the rear of cylinder head to allow air to escape.
13. Run engine until it reaches operating temperature then check coolant level and entire cooling system for leaks.

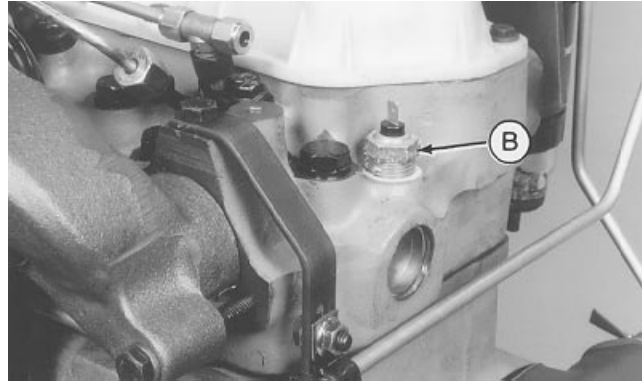

CD30643 -UN-04MAY98

DPSG,CD03523,41 -19-13JUL99-3/3

Maintenance/As required

ADDITIONAL SERVICE INFORMATION

This manual does not allow a complete repair of your engine. If you want more detailed service information the following publications are available from your regular parts channel.

- PC2451 — Parts Catalog
- CTM3274 — Component Technical Manual for 300-Series engines (English)
- CTM104 — Component Technical Manual for POWERTech engines (English)
- CTM67 — Component Technical Manual for OEM Engine accessories (English only)
- CTM77 — Component Technical Manual for Alternators and Starter Motors (English only)

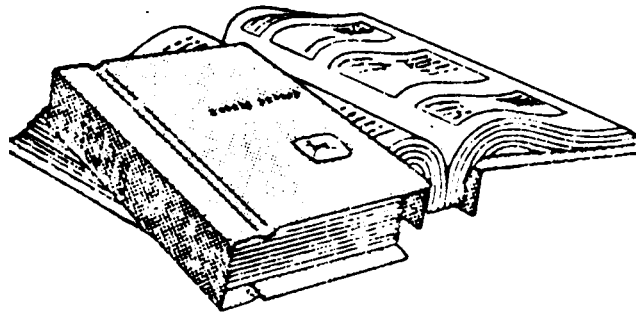

RG4624 -UN-15DEC88

DPSG,CD03523,42 -19-15JUL99-1/1

DO NOT MODIFY FUEL SYSTEM

IMPORTANT: Modification or alteration of the injection pump, the injection pump timing, or the fuel injectors in ways not recommended by the manufacturer will terminate the warranty obligation to the purchaser.

Do not attempt to service injection pump or fuel injectors yourself. Special training and special tools are required (see your authorized servicing dealer or engine distributor).

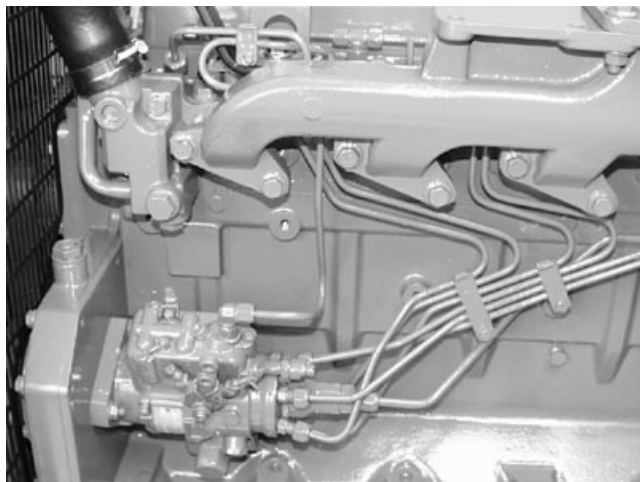

CD30768 -UN-24SEP99

DPSG,CD03523,43 -19-15JUL99-1/1

CLEAN OR REPLACE AIR FILTER (ONE-PIECE)

Clean air filter when restriction indicator (A) is red. Air filter can be cleaned up to six times. Thereafter, or at least once a year, it must be replaced.

Proceed as follows:

1. Thoroughly clean all dirt around air filter area.
2. Loosen clamp (B) then remove air filter.

IMPORTANT: Never reinstall an air filter which shows evidence of bad condition (punched, dented...) allowing no filtered air to enter the engine.

3. Clean air filter with compressed air working from "clean" to "dirty" side.

NOTE: Compressed air must not exceed 600 kPa (6 bar; 88 psi).

4. Mark air filter to keep track of each cleaning operation.
5. Fully depress air restriction indicator reset button and release to reset indicator.
6. Check air system entirely for proper condition (see CHECKING AIR INTAKE SYSTEM).



CD30766 -UN-06SEP99

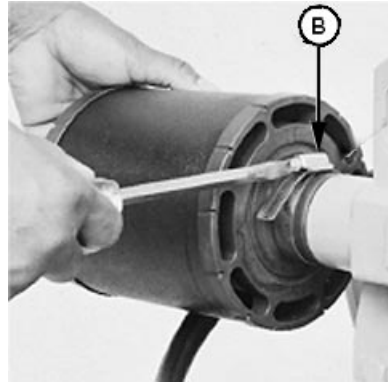

RG9912 -UN-25FEB89

CLEAN OR REPLACE AIR FILTER ELEMENT

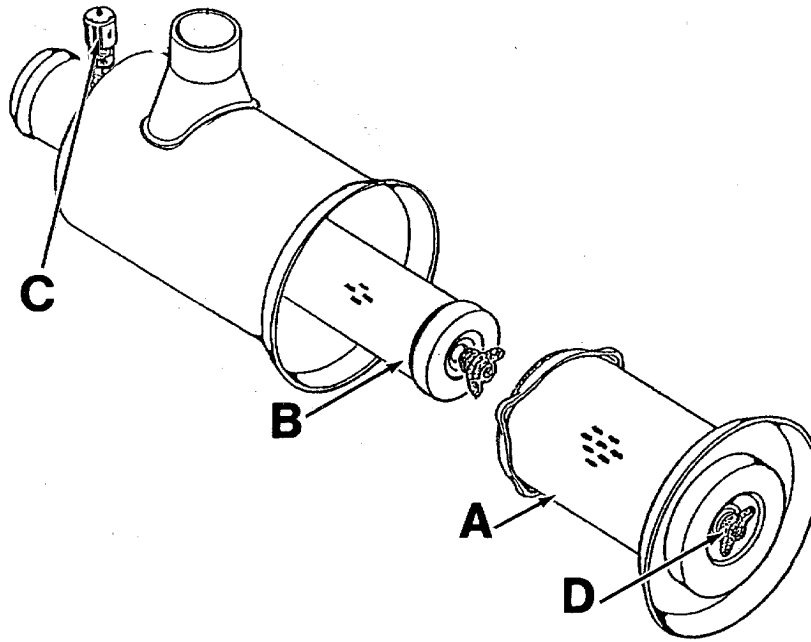

CD30772 -JUN-27AUG99

- A—Primary element
B—Secondary (safety) element
C—Air restriction indicator
D—Wing nut

Clean air filter when restriction indicator (C) is red. Replace both primary (A) and secondary (B) filter elements every 6 primary element cleaning or at least once a year.

Proceed as follows:

1. Thoroughly clean all dirt around air filter area.
2. Remove wing nut (D) and remove primary element (A) from canister.

IMPORTANT: Do not attempt to clean the secondary (safety) element (B). It must be only replaced as recommended.

3. Thoroughly clean all dirt from inside canister.

IMPORTANT: If primary element shows evidence of bad condition (punched,

dented...), replace both the primary and the secondary elements.

4. Clean primary element with compressed air working from "clean" to "dirty" side.

NOTE: Compressed air must not exceed 600 kPa (6 bar; 88 psi).

5. Mark air filter to keep track of each cleaning operation.
6. Fully depress air restriction indicator reset button and release to reset indicator.
7. Check air system entirely for proper condition (see CHECKING AIR INTAKE SYSTEM).

REPLACING FAN AND ALTERNATOR BELT (POWERTECH ENGINES)

NOTE: Refer to CHECKING BELT TENSIONER SPRING TENSION AND BELT WEAR for additional information on the belt tensioner.

1. Inspect belts for cracks, fraying, or stretched out areas. Replace if necessary.
2. On engines with automatic belt tensioner, release tension on belt using a breaker bar and socket on tension arm.

On engines with manual tensioner, loosen cap screws holding the alternator.

3. Remove poly-vee belt from pulleys and discard belt.
4. Install new belt, making sure belt is correctly seated in all pulley grooves. Refer to belt routing at right for your application.
5. Apply tension to belt (see CHECKING BELT).
6. Start engine and check belt alignment.

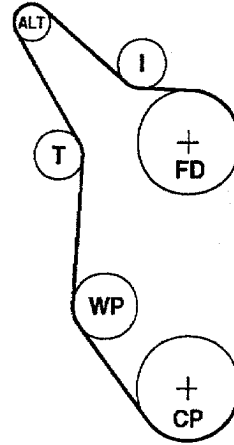

Installation on 4 cyl. engines

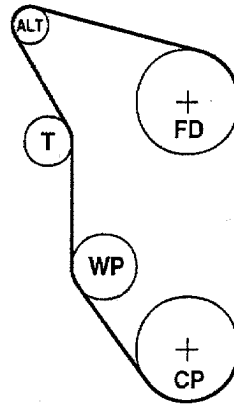

Installation on 6 cyl. engines

ALT—Alternator
CP—Crankshaft Pulley
FD—Fan Drive
I—Idler Pulley
T—Tensioner
WP—Water Pump

CD30769 -UN-01SEP99

CD30770 -UN-01SEP99

DPSG,CD03523,45 -19-15JUL99-1/1

CHECKING FUEL FILTER

Periodically the fuel filter should be checked for water or debris.

IMPORTANT: Drain water into a suitable container and dispose of properly.

1. Loosen drain plug (B) at bottom of fuel filter two or three turns.
2. Loosen air bleed plug two full turns (A) on fuel filter base and drain water from bottom until fuel starts to drain out.
3. When fuel starts to drain out, tighten drain plug securely.
4. After draining water from the fuel filter, the filter must be primed by bleeding all air from the fuel system. Operate primer lever of the fuel supply pump (C) until fuel flow is free from air bubbles.
5. Tighten bleed plug securely, continue operating hand primer until pumping action is not felt. Push hand primer inward (toward engine) as far as it will go.

If the fuel system needs further bleeding of air, see **BLEEDING THE FUEL SYSTEM**.

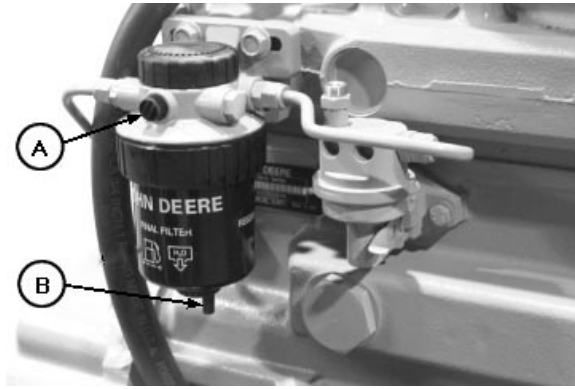

RG9988 -UN-15JAN99

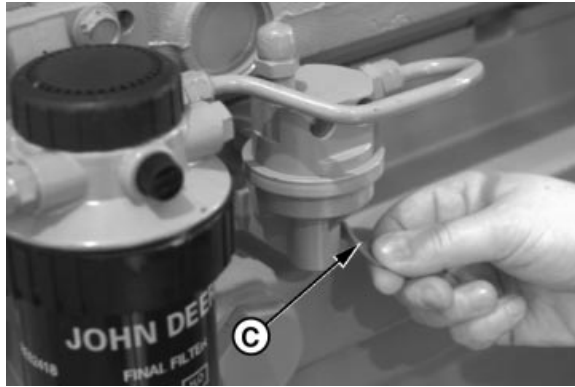

RG8013B -UN-15JAN99

BLEEDING THE FUEL SYSTEM

CAUTION: Escaping fluid under pressure can penetrate the skin causing serious injury. Relieve pressure before disconnecting fuel or other lines. Tighten all connections before applying pressure. Keep hands and body away from pinholes and nozzles which eject fluids under high pressure. Use a piece of cardboard or paper to search for leaks. Do not use your hand.

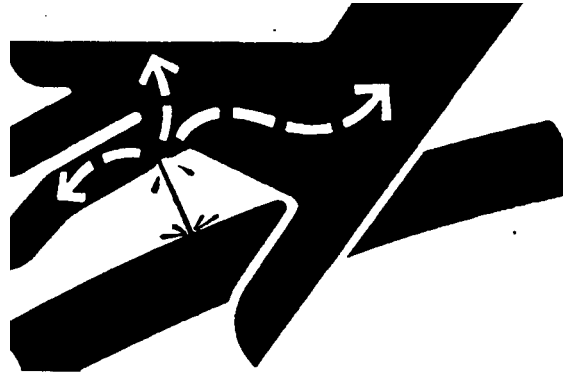

X9811 -UN-23AUG88

If ANY fluid is injected into the skin, it must be surgically removed within a few hours by a doctor familiar with this type injury or gangrene may result. Doctors unfamiliar with this type of injury may call the Deere & Company Medical Department in Moline, Illinois, or other knowledgeable medical source.



RG7947 -UN-13NOV97

Whenever the fuel system has been opened up for service (lines disconnected or filters removed), it will be necessary to bleed air from the system.

1. Loosen the air bleed screw (A) two full turns by hand on fuel filter base.
2. Operate supply pump primer lever (B) until fuel flow is free from air bubbles.
3. Tighten bleed plug securely, continue operating hand primer until pumping action is not felt. Push hand primer inward (toward engine) as far as it will go.
4. Start engine and check for leaks.

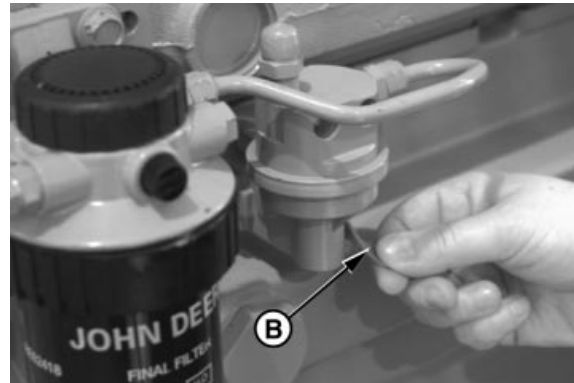

RG8013A -UN-15JAN99

If engine will not start, it may be necessary to bleed air from fuel system at fuel injection pump or injection nozzles as explained next.

Continued on next page

DPSG,CD03523,46 -19-10AUG99-1/2

- **At Fuel Injection Pump:**

- a. Slightly loosen fuel return line connector (C) at fuel injection pump.
- b. Operate fuel supply pump primer lever until fuel, without air bubbles, flows from fuel return line connection.
- c. Tighten return line connector to 16 N•m (12 lb-ft).
- d. Leave hand primer in the inward position toward cylinder block.

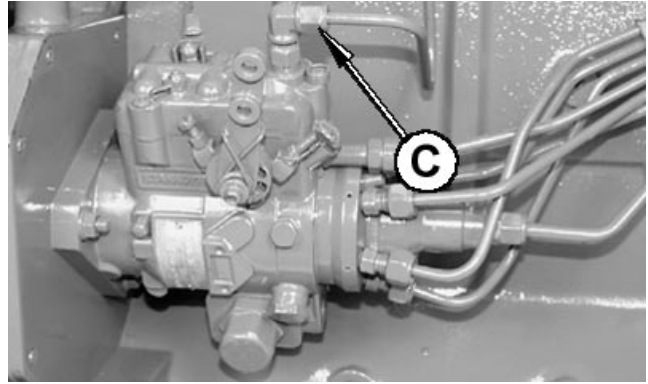

CD30771 -UN-24SEP99

- **At Fuel Injection Nozzles:**

- a. Using two open-end wrenches, loosen fuel line connection at injection nozzle.
- b. Crank engine over with starting motor (but do not start engine), until fuel free from bubbles flows out of loosened connection. Retighten connection to 27 N•m (20 lb-ft).
- c. Repeat procedure for remaining injection nozzles (if necessary) until all air has been removed from fuel system.



RG7725 -UN-08JAN97

If engine still will not start, see your authorized servicing dealer or engine distributor.

Troubleshooting

ENGINE TROUBLESHOOTING

Symptom	Problem	Solution
Engine cranks but will not start	Incorrect starting procedure.	Verify correct starting procedure.
	No fuel.	Check fuel in tank and manual shut-off valve.
	Exhaust restricted.	Check and correct exhaust restriction.
	Fuel filter plugged or full of water.	Replace fuel filter or drain water from filter.
	Injection pump not getting fuel or air in fuel system.	Check fuel flow at supply pump or bleed fuel system.
	Faulty injection pump or nozzles.	Consult authorized diesel repair station for repair or replacement.
Engine hard to start or will not start	Engine starting under load.	Remove load.
	Improper starting procedure.	Review starting procedure.
	No fuel.	Check fuel tank.
	Air in fuel line.	Bleed fuel line.
	Cold weather.	Use cold weather starting aids.
	Slow starter speed.	See "Starter Cranks Slowly".
	Crankcase oil too heavy.	Use oil of correct viscosity.
	Improper type of fuel.	Consult fuel supplier; use proper type fuel for operating conditions.
	Water, dirt or air in fuel system.	Drain, flush, fill and bleed system.
	Clogged fuel filter.	Replace filter element.
	Dirty or faulty injection nozzles.	Have authorized servicing dealer or engine distributor check injectors.

Continued on next page

DPSG,CD03523,49 -19-10AUG99-1/5

Troubleshooting

Symptom	Problem	Solution
	Injection pump shut-off not reset.	Turn key switch to "OFF" then to "ON".
Engine knocks	Low engine oil level.	Add oil to engine crankcase.
	Injection pump out of time.	See your authorized servicing dealer or engine distributor.
	Low coolant temperature.	Remove and check thermostat.
	Engine overheating.	See "Engine Overheats".
Engine runs irregularly or stalls frequently	Low coolant temperature.	Remove and check thermostat.
	Clogged fuel filter.	Replace fuel filter element.
	Water, dirt or air in fuel system.	Drain, flush, fill and bleed system.
	Dirty or faulty injection nozzles.	Have authorized servicing dealer or engine distributor check injectors.
Below normal engine temperature	Defective thermostat.	Remove and check thermostat.
	Defective temperature gauge or sender.	Check gauge, sender and connections.
Lack of power	Engine overloaded.	Reduce load.
	Intake air restriction.	Service air cleaner.
	Clogged fuel filter.	Replace filter element.
	Improper type of fuel.	Use proper fuel.
	Overheated engine.	See "Engine Overheats".
	Below normal engine temperature.	Remove and check thermostat.
	Improper valve clearance.	See your authorized servicing dealer or engine distributor.
	Dirty or faulty injection nozzles.	Have authorized servicing dealer or engine distributor check injectors.

Continued on next page

DPSG,CD03523,49 -19-10AUG99-2/5

Symptom	Problem	Solution
	Injection pump out of time.	See your authorized servicing dealer or engine distributor.
	Turbocharger not functioning.	See your authorized servicing dealer or engine distributor.
	Leaking exhaust manifold gasket.	See your authorized servicing dealer or engine distributor.
	Defective aneroid control line.	See your authorized servicing dealer or engine distributor.
	Restricted fuel hose.	Clean or replace fuel hose.
	Low fast idle speed.	See your authorized servicing dealer or engine distributor.
Low oil pressure	Low oil level.	Add oil.
	Improper type of oil.	Drain and fill crankcase with oil of proper viscosity and quality.
High oil consumption	Crankcase oil too light.	Use oil of correct viscosity.
	Oil leaks.	Check for leaks in lines, gaskets, and drain plug.
	Restricted crankcase vent tube.	Clean vent tube.
	Defective turbocharger.	See your authorized servicing dealer or engine distributor.
Engine emits white smoke	Improper type of fuel.	Use proper fuel.
	Low engine temperature.	Warm up engine to normal operating temperature.
	Defective thermostat.	Remove and check thermostat.
	Defective injection nozzles.	See your authorized servicing dealer or engine distributor.
	Engine out of time.	See your authorized servicing dealer or engine distributor.

Continued on next page

DPSG,CD03523,49 -19-10AUG99-3/5

Symptom	Problem	Solution
Engine emits black or grey exhaust smoke	Improper type of fuel.	Use proper fuel.
	Clogged or dirty air cleaner.	Service air cleaner.
	Engine overloaded.	Reduce load.
	Injection nozzles dirty.	See your authorized servicing dealer or engine distributor.
	Engine out of time.	See your authorized servicing dealer or engine distributor.
	Turbocharger not functioning.	See your authorized servicing dealer or engine distributor.
	Engine overheats	Engine overloaded.
	Low coolant level.	Fill radiator to proper level, check radiator and hoses for loose connections or leaks.
	Faulty radiator cap.	Have serviceman check.
	Stretched poly-vee belt or defective belt tensioner.	Check automatic belt tensioner and check belts for stretching. Replace as required.
	Low engine oil level.	Check oil level. Add oil as required.
	Cooling system needs flushing.	Flush cooling system.
	Defective thermostat.	Remove and check thermostat.
	Defective temperature gauge or sender.	Check coolant temperature with thermometer and replace, if necessary.
	Incorrect grade of fuel.	Use correct grade of fuel.
High fuel consumption	Improper type of fuel.	Use proper type of fuel.
	Clogged or dirty air cleaner.	Service air cleaner.

Troubleshooting

Symptom	Problem	Solution
	Engine overloaded.	Reduce load.
	Improper valve clearance.	See your authorized servicing dealer or engine distributor.
	Injection nozzles dirty.	See your authorized servicing dealer or engine distributor.
	Engine out of time.	See your authorized servicing dealer or engine distributor.
	Defective turbocharger.	See your authorized servicing dealer or engine distributor.
	Low engine temperature.	Check thermostat.

DPSG,CD03523,49 -19-10AUG99-5/5

ELECTRICAL TROUBLESHOOTING

Symptom	Problem	Solution
Undercharged system	Excessive electrical load from added accessories.	Remove accessories or install higher output alternator.
	Excessive engine idling.	Increase engine rpm when heavy electrical load is used.
	Poor electrical connections on battery, ground strap, starter or alternator.	Inspect and clean as necessary.
	Defective battery.	Test battery.
	Defective alternator.	Test charging system.
Battery uses too much water	Cracked battery case.	Check for moisture and replace as necessary.
	Defective battery.	Test battery.
	Battery charging rate too high.	Test charging system.
Battery will not charge	Loose or corroded connections.	Clean and tighten connections.
	Sulfated or worn-out battery.	See your authorized servicing dealer or engine distributor.
	Stretched poly-vee belt or defective belt tensioner.	Adjust belt tension or replace belts.
Starter will not crank	Engine under load	Remove load
	Loose or corroded connections.	Clean and tighten loose connections.
	Low battery output voltage.	See your authorized servicing dealer or engine distributor.
	Faulty start circuit relay.	See your authorized servicing dealer or engine distributor.
	Blown fuse.	Replace fuse.

Troubleshooting

Symptom	Problem	Solution
Starter cranks slowly	Low battery output.	See your authorized servicing dealer or engine distributor.
	Crankcase oil too heavy.	Use proper viscosity oil.
	Loose or corroded connections.	Clean and tighten loose connections.
Entire electrical system	Faulty battery connection.	Clean and tighten connections.
	Sulfated or worn-out battery.	See your authorized servicing dealer or engine distributor.
	Blown fuse.	Replace fuse.

DPSG,CD03523,50 -19-10AUG99-2/2

Storage

ENGINE STORAGE GUIDELINES

1. John Deere engines can be stored outside for up to three (3) months with no long term preparation IF COVERED BY WATERPROOF COVERING.
2. John Deere engines can be stored in a standard overseas shipping container for up to three (3) months with no long term preparation.
3. John Deere engines can be stored inside, warehoused, for up to six (6) months with no long term preparation.
4. John Deere engines expected to be stored more than six (6) months, long term storage preparation

MUST BE taken. (See PREPARING ENGINE FOR LONG TERM STORAGE).

5. For John Deere engines not yet installed in machines, run a line from a container of AR41937 Nucle Oil (from AR41785 Engine Storage Kit) to the fuel transfer pump intake, and another line from the fuel return manifold to the tank, so that Nucle Oil is circulated through the injection system during cranking.

DPSG,CD03523,51 -19-10AUG99-1/1

USE AR41785 ENGINE STORAGE KIT

See your John Deere servicing dealer or engine distributor for an AR41785 Engine Storage Kit. Closely follow instructions provided with this kit.

IMPORTANT: Inhibitors can easily change to gas. Seal or tape each opening immediately after adding inhibitor.



T85452 -UN-06DEC88

DPSG,CD03523,52 -19-10AUG99-1/1

PREPARING ENGINE FOR LONG TERM STORAGE

The following storage preparations are good for long term engine storage up to one year. After that, the engine should be started, warmed up, and retreated for an extended storage period.

IMPORTANT: Any time your engine will not be used for over six (6) months, the following recommendations for storing it and removing it from storage will help to minimize corrosion and deterioration. Use the AR41785 Engine Storage Kit. Follow recommended service procedure included with storage kit.

1. Change engine oil and replace filter. Used oil will not give adequate protection. (See CHANGING ENGINE OIL AND FILTER).
2. Service air cleaner. (See CLEAN OR REPLACE AIR FILTER).
3. Draining and flushing of cooling system is not necessary if engine is to be stored only for several months. However, for extended storage periods of a year or longer, it is recommended that the cooling system be drained, flushed, and refilled. Refill with appropriate coolant. (See DIESEL ENGINE COOLANT).
4. Drain fuel tank and add 30 ml (1 oz) of inhibitor to the fuel tank for each 15 L (4 U.S. gal) of tank capacity. Completely drain fuel filter and close fuel valve, if equipped.
5. Add 30 ml (1 oz) of inhibitor to the engine crankcase for each 0.95 L (1 qt) of crankcase oil.
6. Disconnect air intake piping from the manifold. Pour 90 ml (3 oz) of inhibitor into intake system and reconnect the piping.
7. Crank the engine several revolutions with starter (do not allow the engine to start).
8. Remove fan/alternator belt, if desired.
9. Remove and clean battery. Store them in a cool, dry place and keep them fully charged.
10. Clean the exterior of the engine with salt-free water and touchup any scratched or chipped painted surfaces with a good quality paint.
11. Coat all exposed (machined) metal surfaces with grease or corrosion inhibitor if not feasible to paint.
12. Seal all openings on engine with plastic bags and tape supplied in storage kit. Follow instructions supplied in kit.
13. Store the engine in a dry protected place. If engine must be stored outside, cover it with a waterproof canvas or other suitable protective material and use a strong waterproof tape.

REMOVING ENGINE FROM LONG TERM STORAGE

Refer to the appropriate section for detailed services listed below or have your authorized servicing dealer or engine distributor perform services that you may not be familiar with.

IMPORTANT: DO NOT operate starter more than 30 seconds at a time. Wait at least 2 minutes for starter to cool before trying again.

1. Remove all protective coverings from engine. Unseal all openings in engine and remove covering from electrical systems.
2. Remove the battery from storage. Install battery (fully charged) and connect the terminals.
3. Install fan/alternator belt if removed.
4. Fill fuel tank.
5. Perform all appropriate prestarting checks. (See DAILY PRESTARTING CHECKS).
6. Crank engine for 20 seconds with starter (do not allow the engine to start). Wait 2 minutes and crank engine an additional 20 seconds to assure bearing surfaces are adequately lubricated.
7. Start engine and run at no load for several minutes. Warm up carefully and check all gauges before placing engine under load.
8. On the first day of operation after storage, check overall engine for leaks and check all gauges for correct operation.

DPSG,CD03523,54 -19-10AUG99-1/1

Specifications

GENERAL ENGINE SPECIFICATIONS

ITEM	UNIT OF MEASURE	3029DF128	4039DF008	4039TF008
Number of Cylinders		3	4	4
Fuel		Diesel	Diesel	Diesel
Bore	mm	106.5	106.5	106.5
Stroke	mm	110	110	110
Displacement	L	2.9	3.9	3.9
Compression Ratio		17.8:1	17.8:1	17.8:1
POWER ^a @ 1500 rpm (Prime)	kW (hp)	26 (35)	35 (48)	55 (75)
POWER ^a @ 1500 rpm (Standby)	kW (hp)	30 (41)	38 (52)	61 (83)
POWER ^a @ 1800 rpm (Prime)	kW (hp)	30 (41)	41 (56)	67 (91)
POWER ^a @ 1800 rpm (Standby)	kW (hp)	34 (46)	47 (64)	73 (99)
Width (overall)	mm	582	588	588
Length (overall)	mm	888	1016	1016
Height (overall)	mm	931	960	979
Weight (dry) ^b	kg	345	410	455
Engine oil quantity	L	6	12	12
Engine coolant quantity	L	14.5	16.5	16.5

^aWith Fan

^bApproximate

Continued on next page

DPSG,CD03523,55 -19-10AUG99-1/3

Specifications

ITEM	UNIT OF MEASURE	4045HF158	4045TF158	4045TF258	4045DF158
Number of Cylinders		4	4	4	4
Fuel		Diesel	Diesel	Diesel	Diesel
Bore	mm	106.5	106.5	106.5	106.5
Stroke	mm	127	127	127	127
Displacement	L	4.5	4.5	4.5	4.5
Compression Ratio		17.0:1	17.0:1	17.0:1	17.6:1
POWER ^a @ 1500 rpm (Prime)	kW (hp)	88 (120)	61 (83)	72 (98)	41 (56)
POWER ^a @ 1500 rpm (Standby)	kW (hp)	96 (131)	68 (92)	80 (109)	42 (57)
POWER ^a @ 1800 rpm (Prime)	kW (hp)	108 (147)	72 (98)	80 (109)	48 (65)
POWER ^a @ 1800 rpm (Standby)	kW (hp)	120 (163)	79 (107)	88 (120)	51 (69)
Width (overall)	mm	798	668	668	668
Length (overall)	mm	1356	1219	1219	1219
Height (overall)	mm	1136	1010	1010	1010
Weight (dry) ^b	kg	446	436	436	391
Engine oil quantity	L	12	12	12	8
Engine coolant quantity	L	25	25	25	20

^aWith Fan

^bApproximate

Continued on next page

DPSG,CD03523,55 -19-10AUG99-2/3

Specifications













ITEM	UNIT OF MEASURE	6068HF158	6068TF158	6068TF258
Number of Cylinders		6	6	6
Fuel		Diesel	Diesel	Diesel
Bore	mm	106.5	106.5	106.5
Stroke	mm	127	127	127
Displacement	L	6.8	6.8	6.8
Compression Ratio		17.0:1	17.0:1	17.0:1
POWER ^a @ 1500 rpm (Prime)	kW (hp)	134 (182)	92 (125)	105 (143)
POWER ^a @ 1500 rpm (Standby)	kW (hp)	148 (201)	101 (137)	116 (158)
POWER ^a @ 1800 rpm (Prime)	kW (hp)	164 (223)	108 (147)	124 (169)
POWER ^a @ 1800 rpm (Standby)	kW (hp)	187 (254)	119 (162)	137 (186)
Width (overall)	mm	798	668	668
Length (overall)	mm	1476	1383	1383
Height (overall)	mm	1136	1032	1032
Weight (dry) ^b	kg	613	593	593
Engine oil quantity	L	19.5	19.5	19.5
Engine coolant quantity	L	29	26	26

^aWith Fan

^bApproximate

DPSG,CD03523,55 -19-10AUG99-3/3

UNIFIED INCH BOLT AND CAP SCREW TORQUE VALUES

SAE Grade and Head Markings	NO MARK 	1 or 2 ^b	 5	 5.1	 5.2	 8	 8.2
SAE Grade and Nut Markings	NO MARK 	2	 5			 8	

Size	Grade 1				Grade 2 ^b				Grade 5, 5.1, or 5.2				Grade 8 or 8.2			
	Lubricated ^a		Dry ^a		Lubricated ^a		Dry ^a		Lubricated ^a		Dry ^a		Lubricated ^a		Dry ^a	
	N-m	lb-ft	N-m	lb-ft	N-m	lb-ft	N-m	lb-ft	N-m	lb-ft	N-m	lb-ft	N-m	lb-ft	N-m	lb-ft
1/4	3.7	2.8	4.7	3.5	6	4.5	7.5	5.5	9.5	7	12	9	13.5	10	17	12.5
5/16	7.7	5.5	10	7	12	9	15	11	20	15	25	18	28	21	35	26
3/8	14	10	17	13	22	16	27	20	35	26	44	33	50	36	63	46
7/16	22	16	28	20	35	26	44	32	55	41	70	52	80	58	100	75
1/2	33	25	42	31	53	39	67	50	85	63	110	80	120	90	150	115
9/16	48	36	60	45	75	56	95	70	125	90	155	115	175	130	225	160
5/8	67	50	85	62	105	78	135	100	170	125	215	160	240	175	300	225
3/4	120	87	150	110	190	140	240	175	300	225	375	280	425	310	550	400
7/8	190	140	240	175	190	140	240	175	490	360	625	450	700	500	875	650
1	290	210	360	270	290	210	360	270	725	540	925	675	1050	750	1300	975
1-1/8	400	300	510	375	400	300	510	375	900	675	1150	850	1450	1075	1850	1350
1-1/4	570	425	725	530	570	425	725	530	1300	950	1650	1200	2050	1500	2600	1950
1-3/8	750	550	950	700	750	550	950	700	1700	1250	2150	1550	2700	2000	3400	2550
1-1/2	1000	725	1250	925	990	725	1250	930	2250	1650	2850	2100	3600	2650	4550	3350

DO NOT use these values if a different torque value or tightening procedure is given for a specific application. Torque values listed are for general use only. Check tightness of fasteners periodically.

Fasteners should be replaced with the same or higher grade. If higher grade fasteners are used, these should only be tightened to the strength of the original.

Shear bolts are designed to fail under predetermined loads. Always replace shear bolts with identical grade.

Make sure fasteners threads are clean and that you properly start thread engagement. This will prevent them from failing when tightening.

Tighten plastic insert or crimped steel-type lock nuts to approximately 50 percent of the dry torque shown in the chart, applied to the nut, not to the bolt head. Tighten toothed or serrated-type lock nuts to the full torque value.

^a "Lubricated" means coated with a lubricant such as engine oil, or fasteners with phosphate and oil coatings. "Dry" means plain or zinc plated without any lubrication.

^b Grade 2 applies for hex cap screws (not hex bolts) up to 152 mm (6-in.) long. Grade 1 applies for hex cap screws over 152 mm (6-in.) long, and for all other types of bolts and screws of any length.

METRIC BOLT AND CAP SCREW TORQUE VALUES

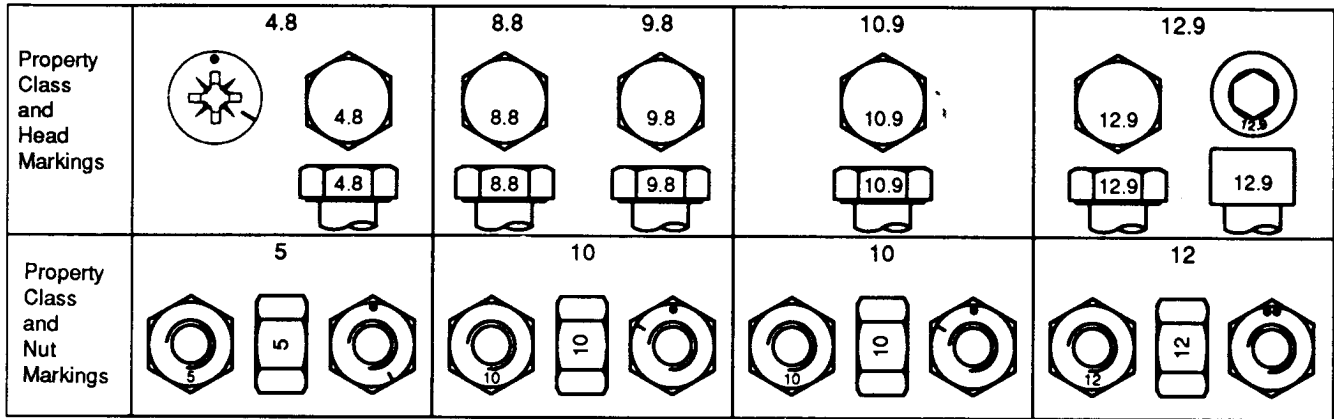

Size	Class 4.8				Class 8.8 or 9.8				Class 10.9				Class 12.9			
	Lubricated ^a		Dry ^a		Lubricated ^a		Dry ^a		Lubricated ^a		Dry ^a		Lubricated ^a		Dry ^a	
	N-m	lb-ft	N-m	lb-ft	N-m	lb-ft	N-m	lb-ft	N-m	lb-ft	N-m	lb-ft	N-m	lb-ft	N-m	lb-ft
M6	4.8	3.5	6	4.5	9	6.5	11	8.5	13	9.5	17	12	15	11.5	19	14.5
M8	12	8.5	15	11	22	16	28	20	32	24	40	30	37	28	47	35
M10	23	17	29	21	43	32	55	40	63	47	80	60	75	55	95	70
M12	40	29	50	37	75	55	95	70	110	80	140	105	130	95	165	120
M14	63	47	80	60	120	88	150	110	175	130	225	165	205	150	260	190
M16	100	73	125	92	190	140	240	175	275	200	350	255	320	240	400	300
M18	135	100	175	125	260	195	330	250	375	275	475	350	440	325	560	410
M20	190	140	240	180	375	275	475	350	530	400	675	500	625	460	800	580
M22	260	190	330	250	510	375	650	475	725	540	925	675	850	625	1075	800
M24	330	250	425	310	650	475	825	600	925	675	1150	850	1075	800	1350	1000
M27	490	360	625	450	950	700	1200	875	1350	1000	1700	1250	1600	1150	2000	1500
M30	675	490	850	625	1300	950	1650	1200	1850	1350	2300	1700	2150	1600	2700	2000
M33	900	675	1150	850	1750	1300	2200	1650	2500	1850	3150	2350	2900	2150	3700	2750
M36	1150	850	1450	1075	2250	1650	2850	2100	3200	2350	4050	3000	3750	2750	4750	3500

DO NOT use these values if a different torque value or tightening procedure is given for a specific application. Torque values listed are for general use only. Check tightness of fasteners periodically.

Shear bolts are designed to fail under predetermined loads. Always replace shear bolts with identical property class.

Fasteners should be replaced with the same or higher property class. If higher property class fasteners are used, these should only be tightened to the strength of the original.

^a "Lubricated" means coated with a lubricant such as engine oil, or fasteners with phosphate and oil coatings. "Dry" means plain or zinc plated without any lubrication.

Make sure fasteners threads are clean and that you properly start thread engagement. This will prevent them from failing when tightening.

Tighten plastic insert or crimped steel-type lock nuts to approximately 50 percent of the dry torque shown in the chart, applied to the nut, not to the bolt head. Tighten toothed or serrated-type lock nuts to the full torque value.

Index

	Page		Page
A		Fuel system	
Air filter		Bleeding	50-6
Clean or replace (one-piece)	50-2	Fuel	
Clean or replace element	50-3	Diesel	10-1
Air intake system		Handling and storing	10-1
Checking	35-1		
B		I	
Belt		Identification views,	01-1
Check automatic tensioner	35-2	Inch torque values	65-4
Check tension	30-4		
Replace (POWERTech)	50-4	L	
Break-in engine oil	10-2	Lubricant	
		Mixing	10-4
		Storage	10-3
C			
Coolant		M	
Diesel engine	10-4	Maintenance records	02-1
Drain and flush cooling system	45-1	Maintenance	
Warm temperature climates	10-5	1000 hours/1 year	
Crankcase vent tube		Check and adjust valve clearance	
Cleaning	03-1, 35-1	(300-Series)	35-3
		Checking air intake system	35-1
		Checking automatic belt tensioner	
		(POWERTech)	35-2
		Cleaning crankcase vent tube	03-1, 35-1
		2000 hours/2 years	
		Adjust speed droop governor	40-3
		Adjust valve clearance (POWERTech)	40-1
		Check engine speed	40-3
		Damper check	40-4
		2500 hours/3 years	
		Drain and flush cooling system	45-1
		50 hours/2 weeks	
		Checking fuel filter	50-5
		500 hours	
		Changing engine oil and filter	30-1
		Checking belt	30-4
		Replace fuel filter	30-3
		As required	
		Additional service information	50-1
		Clean or replace air filter (one-piece)	50-2
		Clean or replace air filter element	50-3
		Do not modify fuel system	50-1
D			
Damper	40-4		
Diesel engine oil	10-3		
Diesel fuel	10-1		
E			
Engine oil			
Break-In	10-2		
Diesel	10-3		
Draining	30-1		
Engine speed	40-3		
F			
Fuel filter			
Replacement	30-3		

Page

Page

Replace fan and alternator belts
(POWERTech) 50-4

Daily or every 10 hours 25-1

Observe service intervals 20-1

Use correct fuel, lubricant and coolant 20-1

Metric torque values 65-5

Mixing lubricants 10-4

O

Operating the engine

Break-in period 15-1

Engine operation 15-4

Standby power units 15-4

Starting the engine 15-1

Stopping the engine 15-5

Using a booster battery or charger 15-3

R

Record keeping

Engine option codes 03-3

Engine serial number plate 03-1

POWERTech medallion 03-1

Record engine serial number 03-2

Record fuel injection pump model number . . . 03-5

S

Specifications

Engine 65-1

Storage

Engine 60-1

Storing fuel 10-1

Storing lubricants 10-3

T

Torque values

Inch 65-4

Metric 65-5

Troubleshooting

Electrical 55-6

Engine 55-1

V

Valve clearance

Adjust (300-Series) 35-3

Adjust (POWERTech) 40-1